

ENGINEERING GUIDE

AMI Modular Air-Handling Units



TABLE OF CONTENTS

PRODUCT OVERVIEW 3

FEATURES AND BENEFITS..... 4

APPLICATION CONSIDERATIONS..... 5

UNIT CONFIGURATION..... 6

ELECTRIC HEAT..... 7

COIL AND FILTER DATA..... 9

STATIC PRESSURE DATA..... 10

WEIGHT DATA..... 12

WEIGHT AND ELECTRICAL DATA 13

FAN PERFORMANCE DATA..... 14

FAN PERFORMANCE CURVES..... 15

GUIDE SPECIFICATIONS 25

METRIC CONVERSION CHART 29

STANDARD & OPTIONAL FEATURES 30

GENERAL NOTES

- Some drawings are not shown in this catalog. Please refer to www.johnsoncontrols.com for complete submittal drawings for your project.
- All data herein is subject to change without notice. Refer to www.johnsoncontrols.com for current catalog and submittal drawings.
- Drawings not for installation purposes; refer to the IOM manual at www.johnsoncontrols.com.
- ETL Report Number 3017723-001.
- MEA Number MEA 107-02-E applies to all units with any combination of chilled water or direct expansion coils and either hot water coils, steam coils, or electric heat.



PRODUCT OVERVIEW

The Perfect Solution for Schools, Hospitals, and Commercial Buildings.

The flexibility of the Model AMI Air-Handling Unit allows you to design the unit to meet the specific project needs. The AMI design allows you to configure draw thru applications in horizontal, vertical, and footprint- saving arrangements. From basic air-handling to the sophisticated isolation room systems required to meet challenging indoor air quality (IAQ), controls, and acoustic (sound sensitive) projects – the Model AMI Air-Handling Unit is your solution!

STANDARD FEATURES

- Modular construction allows for footprint saving arrangements including stacking modules in two-high configuration.
- IAQ galvanized drain pans are double sloped to prevent standing water and minimize microbial growth. Stainless steel drain pans are available.
- Removable access panels for improved accessibility, cleanability, and serviceability. Hinged access doors with quick action latches are available.
- Single point power connection – even with draw thru or blow thru electric heat – simplifies installation. Fan motors are factory mounted and wired to the junction box.
- Available in nine sizes, from 600 to 10,000 CFM.
- Internal spring isolation standard on all unit sizes 02 - 17.
- Single wall and double wall-galvanized construction are available. Double wall construction enhances indoor air quality, protects insulation, and provides the ability to clean the inside of the unit.

OPTIONAL FEATURES

- Factory-packaged air-handling units are available with starters or variable frequency drives, factory mounted and wired. Simply connect power, piping, and ductwork, and the units are ready for operation. An excellent way to minimize installation time, coordination and costs, while increasing reliability.
- Quiet, flexible, acoustical discharge plenums may be used for sound sensitive projects.
- Exhaust / Return Fan with Economizer Sections for use with IAQ applications (“free” heating and cooling – cost savings for space conditioning).
- Customized Options including:
 - Direct drive plenum fans
 - High efficiency filters
 - Double wall perforated lining
 - External face and bypass dampers
 - Inspection windows

FEATURES AND BENEFITS

DESIGNED FOR MAXIMUM FLEXIBILITY

The Johnson Controls Model AMI Air-Handling Unit is designed to maximize flexibility of selection and installation.

The unit is also designed to exceed the stringent quality standards of the institutional market, while remaining cost competitive in the light commercial segment of the market.

Johnson Controls Model AMI sets the new standard for quality, flexibility, and competitive pricing.

FOR THE BUILDING DESIGNER:

OPTIONAL COMPONENTS MEAN FLEXIBILITY

The extensive variety of standard options available on the AMI is where you find the versatility to fit any HVAC system designer's needs.

Options include: Mixing boxes with standard low leak dampers, High efficiency filter sections for 2" prefilter and 4" final filter, blow thru electric heat with single point power connection. All electric heat units are listed with ETL as an assembly and carry the cETL label.

High Efficiency motors, starters, disconnects and fusing mean easier coordination between mechanical and electrical trades.

Coil options allow for 4 or 6 row cooling coils. Water coils have optional circuiting that can be used to reduce Water Pressure Drop, which may also allow for pipe size reductions and lower material cost. Hot Water or Standard Steam coils may be placed in the Preheat or Reheat position.

All Model AMI Air-Handling Units have the option of foil faced insulation.

FOR THE CONTRACTOR:

LOWER INSTALLED COST

Model AMI Air-Handling Units are shipped completely assembled, reducing field installation time and labor. All units are thoroughly inspected and tested prior to shipment, eliminating potential problems at startup. Motor wiring is brought to a junction box on the outside of the unit casing, reducing electrical hook-up time.

A wide variety of fan discharge configurations allow for increased flexibility and easier installation on the job-site, resulting in cost reductions by eliminating expensive elbows, etc.

FOR THE OWNER:

QUALITY PRODUCT

Model AMI Air-Handling Units are built from G60 minimum spangled galvanized steel with a chromate coating. This metal surpasses the ASTM 125 hour salt spray test for corrosion and rust. Standard insulation is 1 inch fiberglass insulation which is glued and pin spotted for maximum positive adhesion. Insulation complies with UL 181 and NFPA 90A.

All units, with or without Electric Heat, are ETL listed and labeled. All wiring is in compliance with NEC, assuring safety and quality for the owner.

APPLICATION CONSIDERATIONS

Model AMI Air-Handling Units offer a wide range of application flexibility, while maintaining a simple, easy to install unit design. These units are intended to provide comfort cooling and heating within a small footprint. They may be applied in many types of building structures including schools, office buildings, hospitals, condominiums, assisted living facilities, apartments or stores. Applications can be constant or variable volume.

There are many applications in which the AMI product can be utilized. Some examples include:

Constant volume applications

- Two-pipe hydronic system for cooling and/or heating
- Two-pipe hydronic cooling system with electric heat
- Four-pipe system with dedicated heating and cooling coils
- Direct Expansion (DX) split systems with hydronic heat
- Direct Expansion (DX) split systems with electric heat

Variable volume applications

- Two-pipe hydronic system for cooling and/or heating.
- Two-pipe hydronic cooling system with electric heat.
- Four-pipe system with dedicated heating and cooling coils.

ACOUSTICS

Control of noise within both occupied and unoccupied spaces has become increasingly important to designers and building owners/ occupants. Proper consideration must be given to placement of indoor air conditioning units, particularly in the occupied space.

Inherent flexibility of the fan and coil combination in the vertical configuration allows application in sound-sensitive areas. In such instances, a fan running at low speed with a high capacity coil normally yields satisfactory results. It also may be desirable to select a larger nominal capacity unit and operate it at a less than nominal airflow for further acoustic benefit.

Three phase motors are recommended for sound-sensitive applications to avoid potential single phase motor hum. Unit operation in the stall region of the fan curve is not recommended since it may cause unsatisfactory noise levels and excessive unit vibration.

INSTALLATION

These floor mounted or ceiling hung units can be installed on a base rail or hanger rods at the corner points. All units have internally isolated fan decks; therefore, flex connections are not required, which will reduce installation costs. One of the most important and basic IAQ issues is condensate management. The first step to ensure trouble-free operation is proper installation. It is very important that the unit be mounted high enough so that the condensate drain from the unit may be properly trapped. Please refer to the AMI IOM Manual at www.johnsoncontrols.com for specifics on this issue. As with all HVAC systems, these units should be installed according to all applicable ASHRAE standards, SMACNA and local code requirements.

OPERATING LIMITATIONS

Units must not be operated above maximum fan speed or unit airflow as listed in the Fan Performance section of this catalog. Unit operation at greater than maximum fan speed could drastically reduce bearing life and may result in a catastrophic failure. Operating at greater than the maximum allowable airflow in the cooling mode may result in unsatisfactory operation due to moisture carry over from the coil. In addition, it is often not economical to operate a unit at its maximum fan speed due to the greater motor power requirements.

Units with electric heat should not be operated with leaving air temperature greater than 104°F, to prevent excessive leaving air temperatures and electric heat limit trips. A hydronic (or steam) coil and electric heat should not be operated simultaneously to prevent excessive leaving air temperatures and limit trips. Electric heat units are equipped with a lockout switch that disables the electric heater if the temperature of the hydronic (or steam) coil is greater than 104°F (40°C).

Water coils must not be operated above a fluid velocity of 8 ft./sec. to reduce the possibility of velocity induced erosion and flow noise. Water coils must not be operated below a fluid velocity of 1 ft./sec. to prevent degraded coil performance caused by laminar flow. These high or low fluid flow rates may not be included in the AHRI coil certification.

UNIT CONFIGURATION

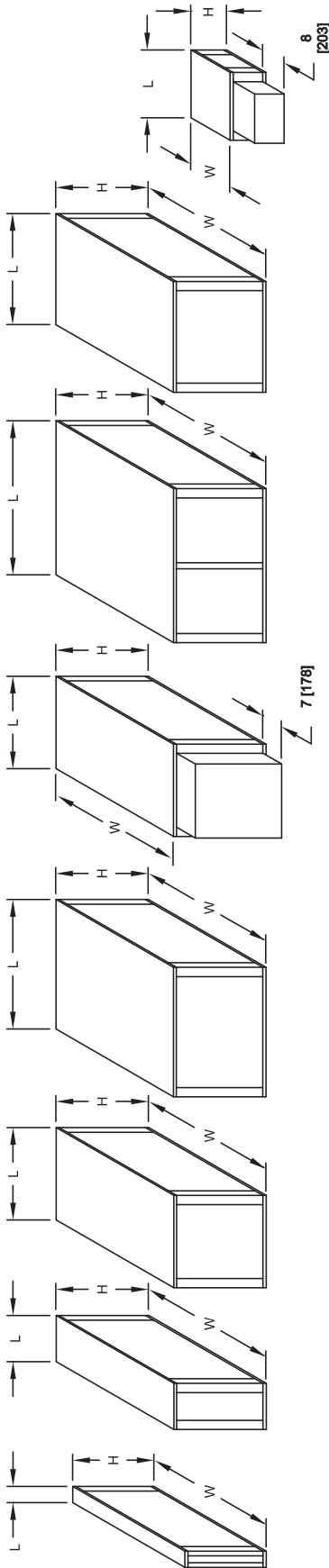

UNIT CONFIGURATION (IN DIRECTION OF AIRFLOW)

AMI - Module Size	Position																
	1	2	3	4	5	6	7	8	9	10	11	12	13	14	15	16	17
EFM	External Flat Filters (2')																
SAM	Small Access																
SCM	Small Coil																
SFM	Small Flat Filters (2" and/or 4" Cartridge)																
MAM	Medium Access																
MCM	Med. INTELLITRAC Mix. Box w/Flat Filters (2')																
MFM	Med. INTELLITRAC Inlet Plenum w/Flat Filters (2')																
MMM	Medium Mixing Box with Flat Filters (2')																
MRM	Medium Inlet Plenum with Flat Filters (2") Medium																
MVM	V-Bank Filters (2')																
HFM	Horizontal FC Fan																
HPM	Horizontal Plug Fan																
RPM	Return FC Fan (requires HEM economizer)																
RFM	Return Plenum Fan (requires HEM economizer)																
VCM	Vertical Coil																
VFM	Vertical FC Fan																
MBM	Medium Face & Bypass																
MTM	Medium Tail Coil																
TM	Small Tail Coil																
EHD	Electric Heat Draw Thru																
LAM	Large Access																
LFM	Lg. INTELLITRAC Mix. Box w/V-Bank Filters (2')																
LIM	Lg. INTELLITRAC Inlet Plenum w/V-Bank Filters (2')																
LRM	Large Mixing Box with V-Bank Filters (2')																
LRM	Large Inlet Plenum with V-Bank Filters (2') Large																
LPM	Discharge Plenum																
FCM	FC Fan and Coil Combination (Horizontal Only)																
HEM	Horizontal Economizer																
EHB	Electric Heat Blow Thru																

Notes:

- All dimensions are $\pm 1/4"$ (6mm). Metric values are soft conversions.
- Section images are for identification of unit configuration only. See individual section submittal drawings at www.johnsoncontrols.com for details.
- Certain configuration rules apply; see catalog and selection program for details.
- All data subject to change without notice.

Fig.1

Fig.2

Fig.2

Fig.2

Fig.2

Fig.3

Fig.4

Fig.4

Fig.5

ELECTRIC HEAT

STANDARD FEATURES

- G60 galvanized steel casing
- Flanged construction for direct unit mounting, in blow thru configuration
- Listed for zero clearance installation
- Meets National Electrical Code requirements
- Ni-Chrome wire in ceramic insulators
- Stainless steel element terminals and hardware
- Element support brackets on maximum 3 1/2" centers
- Solid cover with continuous full height hinge
- Overtemperature protection
- All internal wiring rated for 105°C minimum
- Airflow switch
- Incoming line power distribution block
- ETL Listed in compliance with UL/ANSI Standard 1995
- Single point power connection
- Heater factory mounted to unit with ETL listing as an assembly

OPTIONAL FEATURES

- Main incoming power disconnect (non-fused) (fused)
- Fusing (main) (per stage)
- Magnetic contactors wired for disconnecting operation
- Solid state relay with 4-20 mA, thermistor 0-135 Ohm, 0-16 VDC, or 6-9 VDC control
- Fan control package with heater interlock contacts (required for single point power connection)
- De-rated elements (for longer life)

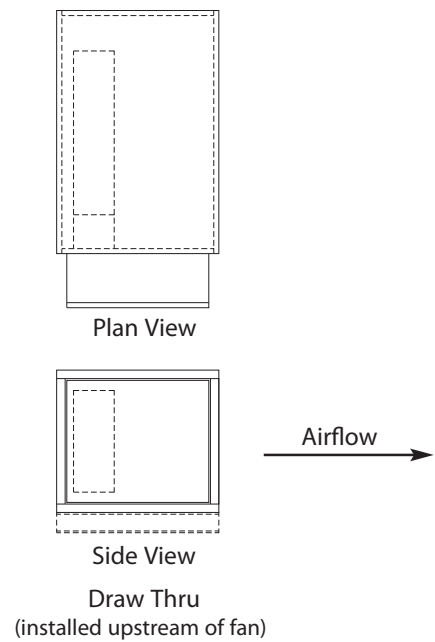
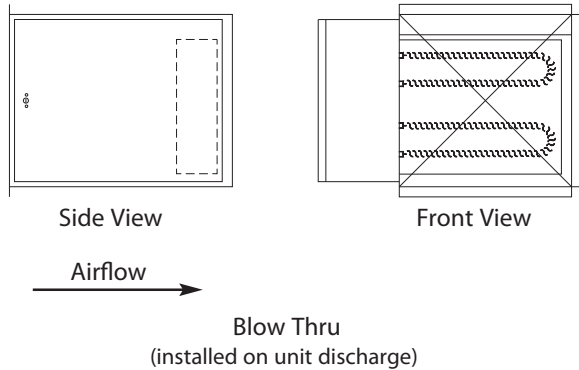

HEATER AMP CALCULATION	
VOLTAGE	AMPs per kW
115/1	8.70
208/1	4.81
230/1	4.35
277/1	3.61
208/3	2.78
230/3	2.51
460/3	1.26
575/3	1.00



1. Non-Fused Door Interlock Disconnect Switch shall be sized according to MCA.
2. Fused Door Interlock Disconnect Switch and Main Fusing shall be sized according to MOP.
3. Heaters above 480v must utilize one time secondary limits only.

UNIT VOLTAGE AND PHASE			BLOW-THRU ELECTRIC HEAT															
			Unit Size															
			2		3		4		6		8		10		12		14	
			Min	Max	Min	Max	Min	Max	Min	Max	Min	Max	Min	Max	Min	Max	Min	Max
Single Phase	115	kW	3	5	3	5	4	5										
		AMPs	26.1	43.5	26.1	43.5	34.8	43.5										
	208	kW	3	9	3	9	4	9	6	9	7	9						
		AMPs	14.4	43.3	14.4	43.3	19.2	43.3	28.8	43.3	33.7	43.3						
	230	kW	3	11	3	11	4	11	6.0	11	7	11	9	11				
		AMPs	13.0	47.8	13.0	47.8	17.4	47.8	26.1	47.8	30.4	47.8	39.1	47.8				
	277	kW	3	13	3	13	4	13	6.0	13	7	13	9	13				
		AMPs	10.8	46.9	10.8	46.9	14.4	46.9	21.7	46.9	25.3	46.9	32.5	46.9				
Three Phase	208	kW	3	13	3	16	4	16	4.0	16	7	16	9	16	12	16	14	16
		AMPs	8.3	36.1	8.3	44.4	11.1	44.4	11.1	44.4	19.4	44.4	25.0	44.4	33.3	44.4	38.9	44.4
	230	kW	3	13	3	18	4	18	4.0	18	7	18	9	18	12	18	14	18
		AMPs	7.5	32.6	7.5	45.2	10.0	45.2	10.0	45.2	17.6	45.2	22.6	45.2	30.1	45.2	35.1	45.2
	460	kW	3	13	3	20	4	26	4.0	26	7	38	9	38	12	38	14	38
		AMPs	3.8	16.3	3.8	25.1	5.0	32.6	5.0	32.6	8.8	47.7	11.3	47.7	15.1	47.7	17.6	47.7
	575	kW	3	13	3	20	4	26	4.0	26	7	46	9	46	12	46	14	46
		AMPs	3.0	13.1	3.0	20.1	4.0	26.1	4.0	26.1	7.0	46.2	9.0	46.2	12.0	46.2	14.1	46.2

Notes:

1. Blow thru heaters can have a maximum of two stages.
2. VFD controllers cannot be supplied with blow thru heaters.
3. Specific kW ratings are available within the ranges shown. Refer to selection program.
4. Heaters above 480v must utilize one time secondary limits only.

UNIT VOLTAGE AND PHASE			DRAW-THRU ELECTRIC HEAT															
			Unit Size															
			2		3		4		6		8		10		12		14	
			Min	Max	Min	Max	Min	Max	Min	Max	Min	Max	Min	Max	Min	Max	Min	Max
Single Phase	115	kW	3	5	3	5	4	5										
		AMPs	26.1	43.5	26.1	43.5	34.8	43.5										
	208	kW	3	10	3	10	4	10	6.0	16	7	16	9	20				
		AMPs	14.4	48.1	14.4	48.1	19.2	48.1	28.8	76.9	33.7	76.9	43.3	96.2				
	230	kW	3	11	3	11	4	11	6.0	18	7	18	9	22				
		AMPs	13.0	47.8	13.0	47.8	17.4	47.8	26.1	78.3	30.4	78.3	39.1	95.7				
	277	kW	3	13	3	13	4	13	6.0	22	7	22	9	26				
		AMPs	10.8	46.9	10.8	46.9	14.4	46.9	21.7	79.4	25.3	79.4	32.5	93.9				
Three Phase	208	kW	3	13	3	20	4	26	4.0	26	7	28	9	34	12	46	14	46
		AMPs	8.3	36.1	8.3	55.5	11.1	72.2	11.1	72.2	19.4	77.7	25.0	94.4	33.3	127.7	38.9	127.7
	230	kW	3	13	3	20	4	26	4.0	26	7	32	9	34	12	49	14	49
		AMPs	7.5	32.6	7.5	50.2	10.0	65.3	10.0	65.3	17.6	80.3	22.6	85.3	30.1	123.0	35.1	123.0
	460	kW	3	13	3	20	4	26	4.0	26	7	52	9	64	12	76	14	88
		AMPs	3.8	16.3	3.8	25.1	5.0	32.6	5.0	32.6	8.8	65.3	11.3	80.3	15.1	95.4	17.6	110.4
	575	kW	3	13	3	20	4	26	4.0	26	7	52	9	64	12	76	14	88
		AMPs	3.0	13.1	3.0	20.1	4.0	26.1	4.0	26.1	7.0	52.2	9.0	64.3	12.0	76.3	14.1	88.4

Notes:

1. Draw thru heaters can have a maximum of four stages.
2. All heaters that have an AMP draw greater than 48 AMPS will have a minimum of two stages.
3. Specific kW ratings are available within the ranges shown. Refer to selection program.
4. Heaters above 480v must utilize one time secondary limits only.

COIL AND FILTER DATA

Johnson Controls offers hot water, chilled water, direct expansion (DX), and standard steam coils for specific application with all Model AMI air-handling units. Coils tested in accordance with AHRI 410, and strict on-site inspection before, during, and after installation guarantees the highest quality and performance available.

Standard Features

- All coils are designed, manufactured and tested by Johnson Controls.
- 1/2" O.D. seamless copper tubes.
- Aluminum fin construction with die-formed spacer collars for uniform spacing.
- Mechanically expanded copper tubes leak tested to a minimum 350 PSIG air pressure under water.
- Manual air vent plug on all water coils.
- Copper ODM sweat connections.
- 300 PSIG working pressure at 200°F.
- Refrigerant coils are factory sealed and charged with a minimum of 5 PSIG nitrogen or refrigerated dry air.
- Refrigerant coils are provided with a fixed orifice distributor. Thermal expansion valves are not included.
- Steam coils rated at maximum for 15 PSIG.
- 0.016" tube wall thickness (0.025" on steam).

Optional Features

- Stainless steel coil casings.
- Automatic air vents on water coils.
- Elevated working pressure ratings.
- Heat pump compatible cooling coils.
- Double circuit DX coils (50-50 split).
- 0.025" tube wall thickness.

COIL AND FILTER DATA							
UNIT SIZES	Coil Face Area	Flat Filters			V-Bank Filters		
		Qty.	Dimensions	Face Area	Qty.	Dimensions	Face Area
02	2.1 [0.20]	1	16x20x2 [406x508x51]	2.2 [0.20]	2	16x20x2 [406x508x51]	4.4 [0.41]
03	2.9 [0.27]	1	16x25x2 [406x635x51]	2.8 [0.26]	2	16x25x2 [406x635x51]	5.6 [0.52]
04	3.8 [0.35]	2	16x20x2 [406x508x51]	4.4 [0.41]	2	20x25x2 [508x635x51]	6.9 [0.64]
06	5.6 [0.52]	2	20x25x2 [508x635x51]	6.9 [0.64]	4	20x20x2 [508x508x51]	11.1 [1.03]
08	7.4 [0.69]	2	20x25x2 [508x635x51]	6.9 [0.64]	2 2	16x20x2 [406x508x51] 20x25x2 [508x635x51]	11.4 [1.06]
10	9.7 [0.90]	1 2	16x25x2 [406x635x51] 20x25x2 [508x635x51]	9.7 [0.90]	2 4	16x20x2 [406x508x51] 20x20x2 [508x508x51]	15.6 [1.45]
12	12.6 [1.17]	4	20x25x2 [508x635x51]	13.9 [1.29]	6	20x25x2 [508x635x51]	20.8 [1.93]
14	14.3 [1.33]	8	16x20x2 [406x508x51]	17.8 [1.65]	3 6	20x25x2 [508x635x51] 20x20x2 [508x508x51]	27.1 [2.52]
17	17.0 [1.58]	6	20x25x2 [508x635x51]	20.8 [1.93]	12	20x20x2 [508x508x51]	33.3 [3.09]

Notes:

1. Standard filters are 2" throwaway; optional filters are 2" pleated.
2. Filter sizes are nominal and standard size, measured in inches [millimeters].
3. Coil and filter face areas are measured in square feet [square meters].
4. Cooling and heating coils have same face area.
5. For coil connection sizes, refer to the Johnson Controls Selection Program.

STATIC PRESSURE DATA

SECTION PRESSURE DROPS

COMPONENT AIR PRESSURE DROP (IN. W.G.)

Unit Size	CFM	Cabinet Losses									Damper Losses			Electric Heater Losses		
		Mixing Box	Econo- mizer	Fan Modules		Filter Mod- ules	Coil Modules		Ac- cess Mod- ules	Ple- num Mod- ule	Mixing Box		Econo- mizer	Blow Thru	Draw Thru	
		MFM LFM MMM LMM	HEM	FCM	RFM VFM	SFM MVM	SCM MCM	VCM	SAM MAM LAM	LPM	MFM LFM	MMM LMM	HEM	EHB	EHD	
2	600	0.01	0.02	0.01	0.01	0.02	0.02	0.02	0.02	0.02	0.02	0.04	0.02	0.04	0.02	0.01
	850	0.02	0.04	0.02	0.02	0.03	0.03	0.04	0.03	0.04	0.04	0.06	0.04	0.07	0.04	0.01
	975	0.02	0.04	0.02	0.02	0.04	0.04	0.04	0.04	0.04	0.04	0.07	0.05	0.09	0.06	0.01
	1100	0.03	0.05	0.03	0.03	0.05	0.05	0.05	0.05	0.05	0.05	0.08	0.06	0.11	0.08	0.01
3	900	0.01	0.02	0.01	0.01	0.02	0.02	0.02	0.02	0.02	0.02	0.06	0.02	0.06	0.05	0.01
	1250	0.02	0.04	0.02	0.02	0.03	0.03	0.04	0.03	0.04	0.04	0.09	0.03	0.10	0.10	0.01
	1425	0.03	0.05	0.02	0.02	0.04	0.04	0.05	0.04	0.05	0.05	0.11	0.04	0.13	0.13	0.01
	1600	0.03	0.06	0.03	0.03	0.05	0.05	0.06	0.05	0.06	0.06	0.13	0.05	0.16	0.17	0.01
4	1200	0.01	0.02	0.01	0.01	0.02	0.02	0.02	0.02	0.02	0.02	0.04	0.02	0.07	0.09	0.01
	1600	0.02	0.03	0.02	0.02	0.03	0.03	0.03	0.03	0.03	0.03	0.06	0.03	0.12	0.17	0.01
	1800	0.02	0.04	0.02	0.02	0.04	0.04	0.04	0.04	0.04	0.04	0.07	0.04	0.15	0.21	0.01
	2000	0.03	0.05	0.02	0.02	0.04	0.04	0.05	0.04	0.05	0.05	0.09	0.05	0.19	0.27	0.01
6	1800	0.01	0.02	0.01	0.01	0.02	0.02	0.02	0.02	0.02	0.02	0.04	0.02	0.07	0.04	0.01
	2500	0.02	0.04	0.02	0.02	0.03	0.03	0.04	0.03	0.04	0.04	0.06	0.03	0.13	0.09	0.01
	2850	0.03	0.05	0.02	0.02	0.04	0.04	0.05	0.04	0.05	0.05	0.08	0.04	0.17	0.12	0.01
	3200	0.03	0.06	0.03	0.03	0.05	0.05	0.06	0.05	0.06	0.06	0.09	0.05	0.21	0.15	0.01
8	2300	0.01	0.02	0.01	0.01	0.02	0.02	0.02	0.02	0.02	0.02	0.03	0.02	0.06	0.07	0.01
	3250	0.02	0.04	0.02	0.02	0.03	0.03	0.04	0.03	0.04	0.04	0.05	0.03	0.12	0.15	0.01
	3725	0.03	0.05	0.02	0.02	0.04	0.04	0.05	0.04	0.05	0.05	0.06	0.04	0.16	0.20	0.01
	4200	0.03	0.06	0.03	0.03	0.05	0.05	0.06	0.05	0.06	0.06	0.07	0.05	0.20	0.26	0.01
10	2900	0.01	0.02	0.01	0.01	0.02	0.02	0.02	0.02	0.02	0.02	0.02	0.02	0.09	0.12	0.01
	4100	0.02	0.04	0.02	0.02	0.03	0.03	0.04	0.03	0.04	0.04	0.04	0.03	0.17	0.25	0.01
	4700	0.03	0.05	0.02	0.02	0.04	0.04	0.05	0.04	0.05	0.05	0.06	0.04	0.22	0.33	0.01
	5300	0.03	0.06	0.03	0.03	0.05	0.05	0.06	0.05	0.06	0.06	0.07	0.05	0.27	0.42	0.01
12	3800	0.01	0.01	0.01	0.01	0.01	0.01	0.01	0.01	0.01	0.01	0.04	0.02	0.08	0.07	0.01
	5325	0.02	0.03	0.01	0.01	0.02	0.02	0.03	0.02	0.03	0.03	0.07	0.04	0.16	0.14	0.01
	6090	0.02	0.03	0.02	0.02	0.03	0.03	0.03	0.03	0.03	0.03	0.09	0.05	0.21	0.18	0.01
	6850	0.02	0.04	0.02	0.02	0.03	0.03	0.04	0.03	0.04	0.04	0.11	0.06	0.26	0.23	0.01
14	4400	0.01	0.02	0.01	0.01	0.01	0.01	0.02	0.01	0.02	0.02	0.02	0.02	0.08	0.09	0.01
	6200	0.02	0.03	0.02	0.02	0.03	0.03	0.03	0.03	0.03	0.03	0.04	0.03	0.15	0.19	0.01
	7100	0.02	0.04	0.02	0.02	0.03	0.03	0.04	0.03	0.04	0.04	0.05	0.04	0.20	0.25	0.01
	8000	0.03	0.05	0.02	0.02	0.04	0.04	0.05	0.04	0.05	0.05	0.07	0.05	0.25	0.32	0.01
17	5100	0.01	0.02	0.01	0.01	0.01	0.01	0.02	0.01	0.02	0.02	0.02	0.02	0.10	0.13	0.01
	7225	0.02	0.03	0.02	0.02	0.03	0.03	0.03	0.03	0.03	0.03	0.04	0.04	0.20	0.26	0.01
	8290	0.02	0.04	0.02	0.02	0.03	0.03	0.04	0.03	0.04	0.04	0.05	0.05	0.26	0.35	0.01
	9350	0.02	0.04	0.02	0.02	0.04	0.04	0.04	0.04	0.04	0.04	0.06	0.06	0.33	0.45	0.01

Notes:

1. Figures do not include pressure drop of internal filter media. Refer to Air Pressure Drop Through Filter Section table for filter air pressure drop adders.
2. Figures do not include pressure drop of internal heating and/or cooling coils. Refer to Air Pressure Drop Through Dry Coil Section table for coil air pressure drop adders.
3. Mixing box with single damper in fully opened position operating at 100% air volume.
4. Economizer with outside air and exhaust dampers in fully opened position operating at 100% air volume.

FILTER PRESSURE DROPS

Filter Type	Size & Efficiency	Air Velocity (FPM)												
		200	250	300	350	400	450	500	550	600	650	700	750	800
High Efficiency Pleated	2" @ 30%	0.12	0.15	0.18	0.21	0.24	0.27	0.30	0.33	0.36	0.39	0.42	0.45	0.48
	4" @ 65%	0.18	0.23	0.27	0.32	0.36	0.41	0.45	0.50	0.54	0.59	0.63	0.68	0.72
	4" @ 85%	0.26	0.33	0.39	0.46	0.52	0.59	0.65	0.72	0.78	0.85	0.91	0.98	1.04
	4" @ 95%	0.30	0.38	0.45	0.53	0.60	0.68	0.75	0.83	0.90	0.98	1.05	1.13	1.20

Notes:

1. Figures listed represent air pressure drop of clean filters.
2. Usable pressure drop across pleated media not recommended to exceed 1.0 inch w.g.
3. Air velocities associated with pressure drops in the shaded region not recommended.

COIL PRESSURE DROPS

AIR PRESSURE DROP THROUGH DRY COIL SECTION (IN. W.G.)														
Rows	Fins per Inch	Air Velocity (FPM)												
		200	250	300	350	400	450	500	550	600	650	700	750	800
1	8	0.01	0.02	0.03	0.04	0.05	0.05	0.06	0.08	0.09	0.10	0.11	0.13	0.14
	10	0.02	0.03	0.03	0.04	0.05	0.06	0.07	0.09	0.10	0.11	0.13	0.15	0.16
	12	0.02	0.03	0.04	0.05	0.06	0.07	0.09	0.10	0.11	0.13	0.15	0.16	0.18
	14	0.02	0.03	0.04	0.05	0.07	0.08	0.10	0.11	0.13	0.14	0.16	0.18	0.20
2	8	0.03	0.04	0.06	0.07	0.09	0.11	0.13	0.15	0.17	0.20	0.23	0.25	0.28
	10	0.04	0.05	0.07	0.09	0.11	0.13	0.15	0.17	0.20	0.23	0.26	0.29	0.32
	12	0.04	0.06	0.08	0.10	0.12	0.14	0.17	0.20	0.23	0.26	0.29	0.33	0.36
	14	0.05	0.07	0.09	0.11	0.13	0.16	0.19	0.22	0.25	0.29	0.33	0.36	0.40
3	8	0.04	0.06	0.09	0.11	0.14	0.16	0.19	0.23	0.26	0.30	0.34	0.38	0.42
	10	0.05	0.08	0.10	0.13	0.16	0.19	0.22	0.26	0.30	0.34	0.39	0.44	0.48
	12	0.06	0.09	0.12	0.15	0.18	0.22	0.26	0.30	0.34	0.39	0.44	0.49	0.55
	14	0.07	0.10	0.13	0.16	0.20	0.24	0.29	0.33	0.38	0.43	0.49	0.55	0.61
4	8	0.06	0.09	0.11	0.15	0.18	0.22	0.26	0.30	0.35	0.40	0.45	0.51	0.57
	10	0.07	0.10	0.13	0.17	0.21	0.25	0.30	0.35	0.40	0.46	0.52	0.58	0.65
	12	0.08	0.12	0.15	0.19	0.24	0.29	0.34	0.40	0.46	0.52	0.58	0.65	0.73
	14	0.09	0.13	0.17	0.22	0.27	0.32	0.38	0.44	0.51	0.58	0.65	0.73	0.81
6	8	0.09	0.13	0.17	0.22	0.27	0.33	0.39	0.45	0.52	0.60	0.68	0.76	0.85
	10	0.11	0.15	0.20	0.26	0.32	0.38	0.45	0.52	0.60	0.69	0.78	0.87	0.97
	12	0.12	0.17	0.23	0.29	0.36	0.43	0.51	0.59	0.68	0.78	0.88	0.98	1.09
	14	0.14	0.20	0.26	0.33	0.40	0.48	0.57	0.66	0.76	0.87	0.98	1.09	1.21
8	8	0.12	0.17	0.23	0.29	0.36	0.44	0.52	0.61	0.70	0.80	0.90	1.01	1.13
	10	0.14	0.20	0.27	0.34	0.42	0.51	0.60	0.70	0.80	0.92	1.04	1.16	1.29
	12	0.16	0.23	0.31	0.39	0.48	0.58	0.68	0.79	0.91	1.04	1.17	1.31	1.45
	14	0.19	0.26	0.35	0.44	0.54	0.65	0.76	0.89	1.02	1.15	1.30	1.46	1.62

Note: Dehumidifying cooling coils with face velocities exceeding 525 fpm not recommended.

WEIGHT DATA

Coil Weight Data

COIL WEIGHTS													
UNIT SIZE	COIL ROWS	DRY COIL				100% WATER				40% GLYCOL			
		8 FPI	10 FPI	12 FPI	14 FPI	8 FPI	10 FPI	12 FPI	14 FPI	8 FPI	10 FPI	12 FPI	14 FPI
2	1	10 (5)	11 (5)	11 (5)	11 (5)	12 (5)	12 (5)	13 (6)	13 (6)	12 (5)	12 (5)	13 (6)	13 (6)
	2	16 (7)	16 (7)	17 (8)	18 (8)	19 (9)	20 (9)	21 (10)	21 (10)	20 (9)	20 (9)	21 (10)	22 (10)
	3	21 (10)	22 (10)	23 (11)	24 (11)	27 (12)	28 (13)	29 (13)	30 (14)	27 (12)	28 (13)	29 (13)	30 (14)
	4	28 (13)	29 (13)	30 (14)	32 (14)	35 (16)	36 (16)	37 (17)	39 (18)	35 (16)	36 (16)	38 (17)	39 (18)
	6	40 (18)	42 (19)	44 (20)	46 (21)	51 (23)	53 (24)	55 (25)	57 (26)	51 (23)	53 (24)	55 (25)	58 (26)
	8	57 (26)	61 (28)	65 (30)	69 (31)	71 (32)	75 (34)	79 (36)	83 (38)	72 (33)	76 (34)	80 (36)	84 (38)
3	1	13 (6)	13 (6)	13 (6)	14 (6)	15 (7)	16 (7)	16 (7)	17 (8)	15 (7)	16 (7)	16 (7)	17 (8)
	2	19 (9)	20 (9)	21 (10)	22 (10)	24 (11)	25 (12)	26 (12)	27 (12)	25 (11)	26 (12)	27 (12)	28 (13)
	3	26 (12)	28 (13)	29 (13)	31 (14)	34 (15)	35 (16)	37 (17)	38 (17)	34 (15)	36 (16)	37 (17)	39 (17)
	4	34 (15)	36 (16)	38 (17)	40 (18)	44 (20)	46 (21)	48 (22)	50 (23)	44 (20)	46 (21)	48 (22)	50 (23)
	6	50 (23)	53 (24)	56 (25)	59 (27)	64 (29)	67 (31)	70 (32)	73 (33)	65 (20)	68 (31)	71 (32)	74 (34)
	8	71 (32)	76 (34)	81 (37)	86 (39)	89 (41)	95 (43)	100 (45)	105 (47)	91 (41)	96 (43)	101 (46)	106 (48)
4	1	15 (7)	15 (7)	16 (7)	17 (8)	18 (8)	18 (8)	19 (9)	20 (9)	18 (8)	19 (9)	19 (9)	20 (9)
	2	23 (11)	24 (11)	26 (12)	27 (12)	29 (13)	30 (14)	32 (15)	33 (15)	30 (13)	31 (14)	32 (15)	33 (15)
	3	32 (14)	33 (15)	35 (16)	37 (17)	40 (18)	42 (19)	44 (20)	46 (21)	41 (19)	43 (19)	45 (20)	47 (21)
	4	41 (19)	44 (20)	46 (21)	49 (22)	53 (24)	55 (25)	58 (26)	60 (27)	54 (24)	56 (25)	59 (27)	61 (28)
	6	60 (27)	64 (29)	68 (31)	72 (33)	78 (35)	82 (37)	86 (39)	89 (41)	79 (36)	83 (38)	87 (39)	90 (41)
	8	80 (36)	85 (38)	90 (41)	95 (43)	103 (47)	108 (49)	113 (51)	118 (54)	105 (47)	110 (50)	115 (52)	120 (54)
6	1	19 (9)	20 (9)	21 (10)	22 (10)	24 (11)	25 (11)	26 (12)	27 (12)	24 (11)	25 (11)	26 (12)	27 (12)
	2	32 (14)	34 (15)	36 (16)	38 (17)	41 (19)	43 (20)	45 (20)	47 (21)	42 (19)	43 (20)	45 (20)	47 (21)
	3	45 (20)	48 (22)	50 (23)	53 (24)	58 (26)	61 (28)	64 (29)	67 (30)	59 (27)	62 (28)	65 (29)	67 (30)
	4	59 (27)	62 (28)	66 (30)	70 (32)	76 (35)	80 (36)	84 (38)	88 (40)	77 (35)	81 (37)	85 (39)	89 (40)
	6	87 (39)	92 (42)	98 (44)	104 (47)	113 (51)	119 (54)	124 (56)	130 (59)	115 (52)	120 (55)	126 (57)	132 (60)
	8	117 (53)	125 (57)	133 (61)	142 (64)	152 (69)	160 (73)	169 (77)	177 (80)	155 (70)	163 (74)	171 (78)	179 (81)
8	1	23 (11)	25 (11)	26 (12)	27 (12)	30 (14)	31 (14)	32 (15)	33 (15)	30 (14)	31 (14)	32 (15)	34 (15)
	2	40 (18)	43 (19)	45 (20)	48 (22)	52 (24)	54 (25)	57 (26)	59 (27)	53 (24)	55 (25)	58 (26)	60 (27)
	3	57 (26)	61 (27)	64 (29)	68 (31)	75 (34)	78 (36)	82 (37)	86 (39)	76 (34)	79 (36)	83 (38)	87 (39)
	4	75 (34)	80 (36)	85 (38)	90 (41)	98 (45)	103 (47)	108 (49)	113 (51)	100 (45)	105 (47)	110 (50)	115 (52)
	6	111 (50)	118 (54)	126 (57)	133 (60)	146 (66)	153 (69)	161 (73)	168 (76)	148 (67)	155 (70)	163 (74)	170 (77)
	8	157 (71)	169 (77)	182 (83)	195 (88)	204 (92)	216 (98)	229 (104)	241 (110)	207 (94)	219 (99)	232 (105)	245 (111)
10	1	28 (13)	30 (13)	31 (14)	33 (15)	36 (16)	37 (17)	39 (18)	40 (18)	36 (16)	38 (17)	39 (18)	41 (18)
	2	48 (22)	51 (23)	54 (25)	57 (26)	63 (28)	66 (30)	69 (31)	72 (33)	64 (29)	67 (30)	70 (32)	73 (33)
	3	68 (31)	73 (33)	77 (35)	82 (37)	90 (41)	95 (43)	99 (45)	104 (47)	91 (41)	96 (44)	101 (46)	106 (48)
	4	89 (41)	96 (43)	102 (46)	108 (49)	119 (54)	125 (57)	131 (60)	138 (62)	120 (55)	127 (58)	133 (60)	139 (63)
	6	133 (60)	142 (64)	152 (69)	161 (73)	176 (80)	186 (84)	195 (88)	204 (93)	179 (81)	188 (85)	198 (90)	207 (94)
	8	183 (83)	197 (90)	212 (96)	226 (103)	241 (109)	255 (116)	270 (122)	284 (129)	244 (111)	259 (117)	273 (124)	288 (131)
12	1	35 (16)	37 (17)	39 (18)	42 (19)	45 (21)	48 (22)	50 (23)	52 (24)	46 (21)	48 (22)	50 (23)	52 (24)
	2	62 (28)	66 (30)	70 (32)	74 (34)	81 (37)	86 (39)	90 (41)	94 (43)	83 (38)	87 (39)	91 (41)	95 (43)
	3	88 (40)	94 (43)	101 (46)	107 (49)	118 (53)	124 (56)	130 (59)	137 (62)	119 (54)	126 (57)	132 (60)	139 (63)
	4	116 (53)	125 (57)	133 (60)	142 (64)	155 (70)	164 (74)	172 (78)	181 (82)	158 (72)	166 (75)	175 (79)	184 (83)
	6	173 (78)	186 (84)	199 (90)	211 (96)	231 (105)	244 (111)	257 (117)	270 (122)	235 (107)	248 (112)	261 (118)	274 (124)
	8	233 (106)	251 (114)	269 (122)	287 (130)	311 (141)	329 (149)	347 (157)	365 (165)	316 (143)	334 (151)	352 (160)	370 (168)
14	1	39 (18)	41 (19)	44 (20)	46 (21)	50 (23)	53 (24)	55 (25)	58 (26)	51 (23)	54 (24)	56 (25)	58 (26)
	2	69 (31)	74 (33)	78 (36)	83 (38)	91 (41)	96 (43)	101 (46)	106 (48)	92 (42)	97 (44)	102 (46)	107 (49)
	3	98 (45)	106 (48)	113 (51)	120 (55)	132 (60)	139 (63)	146 (66)	154 (70)	134 (61)	141 (64)	149 (67)	156 (71)
	4	130 (59)	140 (63)	149 (68)	159 (72)	174 (79)	184 (83)	194 (88)	203 (92)	177 (80)	187 (85)	197 (89)	206 (94)
	6	194 (88)	208 (94)	223 (101)	237 (108)	260 (118)	274 (124)	289 (131)	303 (138)	264 (120)	279 (126)	293 (133)	308 (140)
	8	272 (123)	295 (134)	318 (144)	341 (155)	359 (163)	382 (173)	405 (184)	428 (194)	365 (166)	388 (176)	411 (186)	434 (197)
17	1	45 (20)	48 (22)	51 (23)	53 (24)	58 (26)	61 (28)	64 (29)	67 (30)	59 (27)	62 (28)	65 (29)	68 (31)
	2	79 (36)	85 (39)	91 (41)	97 (44)	106 (48)	112 (51)	117 (53)	123 (56)	108 (49)	113 (51)	119 (54)	125 (57)
	3	114 (52)	122 (56)	131 (59)	140 (63)	153 (69)	162 (73)	170 (77)	179 (81)	155 (71)	164 (74)	173 (78)	181 (82)
	4	150 (68)	162 (73)	173 (79)	185 (84)	203 (92)	214 (97)	226 (102)	237 (108)	206 (93)	217 (99)	229 (104)	240 (109)
	6	224 (102)	241 (109)	259 (117)	276 (125)	302 (137)	319 (145)	336 (153)	354 (160)	307 (139)	324 (147)	341 (155)	359 (163)
	8	206 (93)	206 (93)	206 (93)	206 (93)	309 (140)	309 (140)	309 (140)	309 (140)	315 (143)	315 (143)	315 (143)	315 (143)

NOTE: Unit weight data is shipping weight in pounds (kilograms).

WEIGHT AND ELECTRICAL DATA

MOTOR/DRIVE WEIGHT DATA

MOTOR TYPE	MOTOR WEIGHTS										
	MOTOR HORSEPOWER										
	1/3	1/2	3/4	1	1 1/2	2	3	5	7 1/2	10	15
ODP	25 [11]	28 [13]	30 [762]	35 [16]	45 [20]	35 [16]	75 [34]	100 [45]	125 [57]	125 [57]	220 [100]
TEFC	28 [13]	35 [16]	33 [338]	45 [20]	65 [29]	70 [32]	85 [39]	105 [48]	145 [66]	160 [73]	295 [134]
E+	N/A	N/A	N/A	40 [18]	55 [25]	55 [25]	90 [41]	100 [45]	145 [66]	130 [59]	300 [136]
2 SPEED	45 [20]	35 [16]	33 [338]	45 [20]	40 [18]	70 [32]	75 [34]	N/A	N/A	N/A	N/A

Notes:

1. Includes motor, pulleys, belts, and motor base.
2. Motor/drive weight data is shipping weight in pounds [kilograms].

MOTOR ELECTRICAL DATA

HORSEPOWER	MAXIMUM MOTOR AMPERAGE								
	VOLTAGE								
	115/1	208/1	230/1	277/1	208/3	230/3	460/3	575/3	
1/3	6.3	3.5	3.2	2.6	1.7	1.5	0.8	-	
1/2	7.8	4.3	3.9	3.6	2.2	2.1	1.1	0.9	
3/4	10.6	5.4	5.3	5.0	3.2	3.0	1.5	1.2	
1	15.0	8.3	7.5	5.5	4.0	3.6	1.8	1.4	
1 1/2	-	-	-	-	5.3	5.0	2.5	1.9	
2	-	-	-	-	7.0	6.4	3.2	2.5	
3	-	-	-	-	9.1	9.0	4.5	3.2	
5	-	-	-	-	14.2	12.8	6.4	5.2	
7 1/2	-	-	-	-	22.2	21.6	10.8	8.2	
10	-	-	-	-	28.6	28.4	14.2	11.4	
15	-	-	-	-	44.9	40.6	20.3	16.2	

NOTES:

1. Actual motor nameplate AMPs may vary, but will not exceed values shown.
2. Consult factory for applications requiring special motors.

GENERAL FAN NOTES

Forward curved Fans (Belt Drive)

1. Consult factory for applications at operating conditions not in the following table and curves.
2. Fan motor voltage, fan rotation, and fan RPM may require field setting/adjustment.
3. Drive losses not included in fan performance table and curves.
4. In direction of airflow, after fan discharge – only LPM (Large Plenum) and EHB (Electric Heat Blow Thru) are available.
5. Section will have internal isolation.

Plenum Fans (Direct Drive)

1. Consult factory for applications at specific operating conditions.
2. VFD's are recommended for operation and field balancing of units whether factory supplied and factory mounted, field supplied and factory mounted, or field supplied and field mounted.
3. In direction of airflow, there must be space prior to the plug fan inlet. For sizes 02 through 06, the minimum requirement is either an SAM (Small Access) or an MCM (Medium Coil). For sizes 08 through 17, the minimum requirement is an MAM (Medium Access).
4. Section will have internal isolation.

FAN PERFORMANCE DATA

Forward Curved Fan Performance Data

TSP (in-wg)	UNIT SIZE	02					03					04				
		Actual CFM	650	750	850	950	1050	950	1100	1250	1400	1550	1200	1400	1600	1800
3.5	RPM	—	—	—	—	—	—	—	—	—	2160	—	—	—	—	1880
	BHP	—	—	—	—	—	—	—	—	—	1.82	—	—	—	—	2.09
3.0	RPM	—	—	—	—	—	—	—	—	1990	2025	—	—	—	1740	1750
	BHP	—	—	—	—	—	—	—	—	1.39	1.60	—	—	—	1.60	1.84
2.5	RPM	—	—	—	—	—	—	—	1810	1845	1890	—	—	—	1595	1625
	BHP	—	—	—	—	—	—	—	1.03	1.20	1.40	—	—	—	1.37	1.62
2.0	RPM	—	—	—	—	1725	—	1615	1650	1695	1740	—	—	1425	1455	1490
	BHP	—	—	—	—	0.86	—	0.72	0.86	1.01	1.19	—	—	0.97	1.17	1.39
1.5	RPM	—	—	1485	1515	1570	1400	1435	1475	1525	1575	—	1235	1265	1305	1355
	BHP	—	—	0.53	0.59	0.69	0.47	0.57	0.69	0.83	1.00	—	0.64	0.79	0.97	1.18
1.0	RPM	1200	1225	1275	1345	1430	1185	1230	1280	1330	1390	1015	1050	1095	1145	*
	BHP	0.27	0.31	0.37	0.45	0.56	0.34	0.42	0.53	0.66	0.80	0.37	0.48	0.61	0.78	*
0.5	RPM	935	1020	1110	*	*	930	985	*	*	*	790	*	*	*	*
	BHP	0.15	0.20	0.27	*	*	0.22	0.29	*	*	*	0.24	*	*	*	*

TSP (in-wg)	UNIT SIZE	06					08					10				
		Actual CFM	1900	2200	2500	2800	3100	2400	2800	3200	3600	4000	3100	3600	4100	4600
3.5	RPM	—	—	—	—	1615	—	—	—	—	1555	—	—	—	1345	1375
	BHP	—	—	—	—	3.41	—	—	—	—	4.24	—	—	—	4.62	5.41
3.0	RPM	—	—	—	1490	1510	—	—	—	1435	1460	—	—	1235	1260	1295
	BHP	—	—	—	2.61	3.01	—	—	—	3.23	3.80	—	—	3.43	4.09	4.80
2.5	RPM	—	—	1360	1375	1400	—	—	1305	1330	1360	—	1125	1145	1180	1220
	BHP	—	—	1.93	2.25	2.63	—	—	2.36	2.83	3.38	—	2.46	3.01	3.60	4.37
2.0	RPM	—	1215	1230	1255	1280	—	1165	1190	1220	1250	1000	1020	1055	1095	1135
	BHP	—	1.35	1.61	1.91	2.25	—	1.64	2.01	2.45	2.95	1.65	2.10	2.56	3.18	3.90
1.5	RPM	1050	1070	1090	1125	1160	1010	1030	1060	1100	1140	885	915	955	1000	1045
	BHP	0.87	1.07	1.30	1.59	1.92	1.05	1.32	1.66	2.07	2.56	1.36	1.69	2.18	2.76	3.42
1.0	RPM	880	905	945	990	*	850	885	925	970	*	760	805	850	*	*
	BHP	0.63	0.80	1.02	1.29	*	0.78	1.03	1.34	1.71	*	1.02	1.38	1.81	*	*
0.5	RPM	690	*	*	*	*	670	*	*	*	*	*	*	*	*	*
	BHP	0.42	*	*	*	*	0.54	*	*	*	*	*	*	*	*	*

TSP (in-wg)	UNIT SIZE	12					14					17				
		Actual CFM	3900	4600	5300	6000	6700	4600	5400	6200	7000	7800	5200	6200	7200	8200
3.5	RPM	—	—	—	—	—	—	—	—	—	—	—	—	—	—	1095
	BHP	—	—	—	—	—	—	—	—	—	—	—	—	—	—	9.25
3.0	RPM	—	—	—	—	—	—	—	—	—	—	—	—	—	1010	1025
	BHP	—	—	—	—	—	—	—	—	—	—	—	—	—	6.98	8.34
2.5	RPM	—	—	—	—	900	—	—	—	—	905	—	—	920	930	950
	BHP	—	—	—	—	4.50	—	—	—	—	5.33	—	—	5.05	6.06	7.42
2.0	RPM	—	—	—	805	815	—	—	—	810	820	—	—	830	850	875
	BHP	—	—	—	3.22	3.88	—	—	—	3.84	4.58	—	—	4.20	5.29	6.52
1.5	RPM	—	—	695	710	725	—	—	705	715	730	—	720	740	760	785
	BHP	—	—	2.15	2.67	3.24	—	—	2.60	3.16	3.83	—	2.71	3.53	4.43	5.48
1.0	RPM	—	575	590	605	*	—	580	590	610	635	590	610	635	*	*
	BHP	—	1.31	1.68	2.05	*	—	1.57	1.97	2.48	3.11	1.55	2.11	2.77	*	*
0.5	RPM	420	*	*	*	*	425	445	*	*	*	450	*	*	*	*
	BHP	0.63	*	*	*	*	0.77	1.05	*	*	*	1.01	*	*	*	*

* Contact Factory

FAN PERFORMANCE CURVES

AMI02 (Fan 09-04 Class I)

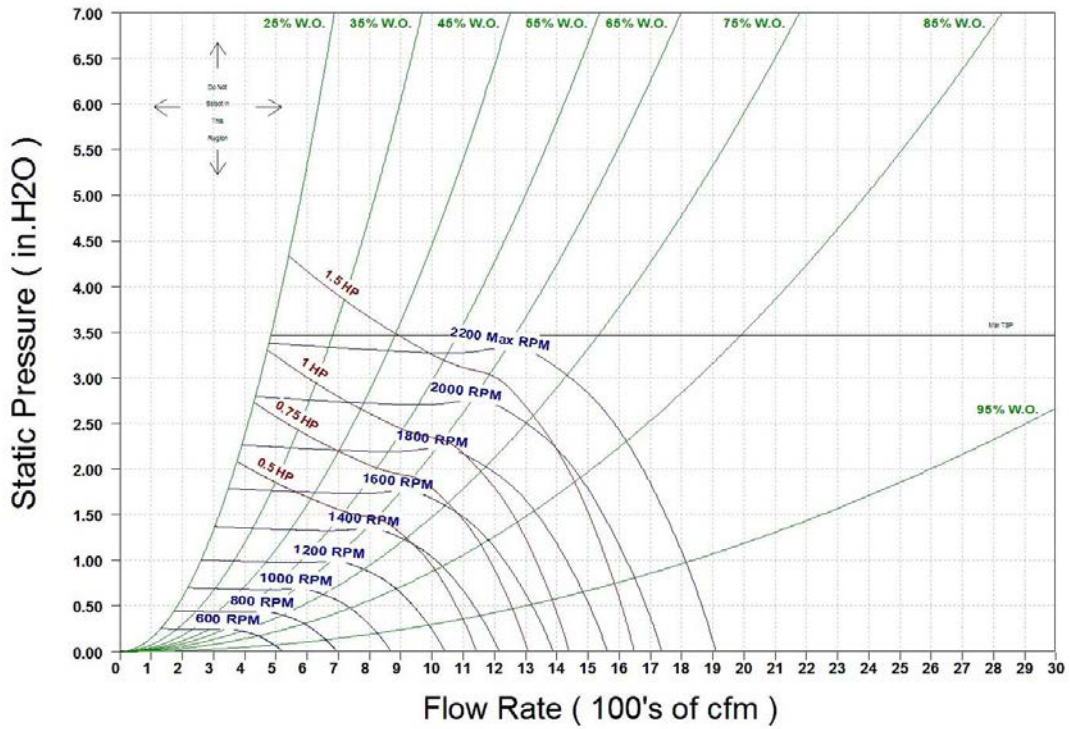

AMI03 (Fan 09-06 Class I)

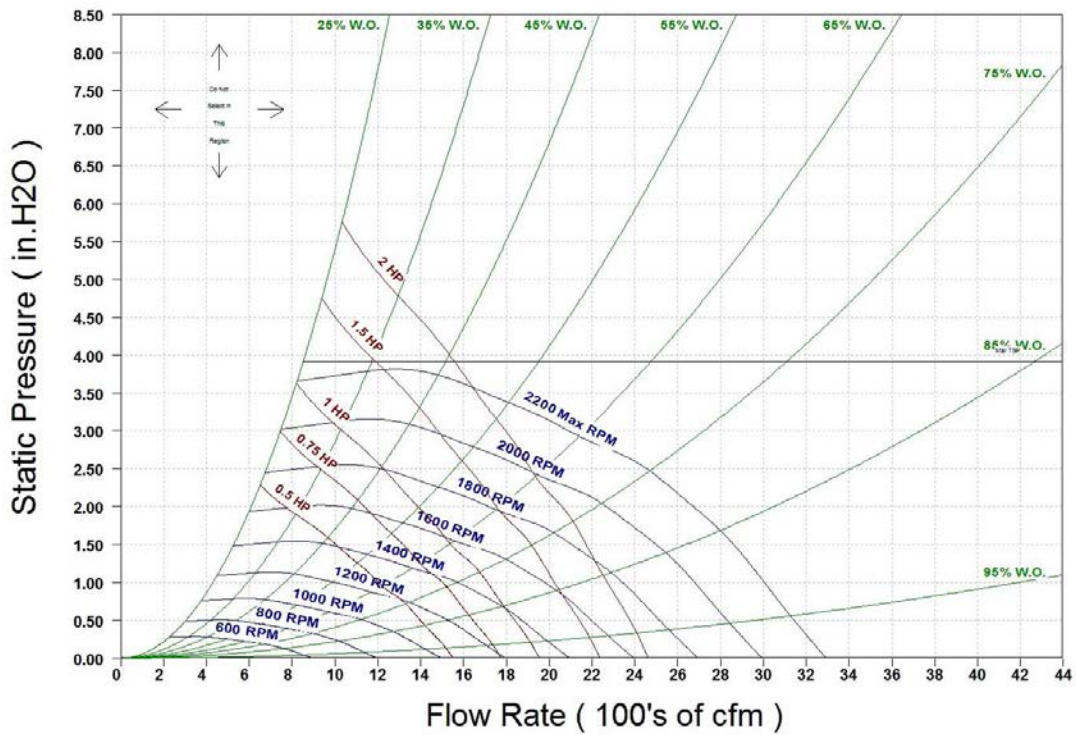

AMI04 (Fan 10-07 Class I)

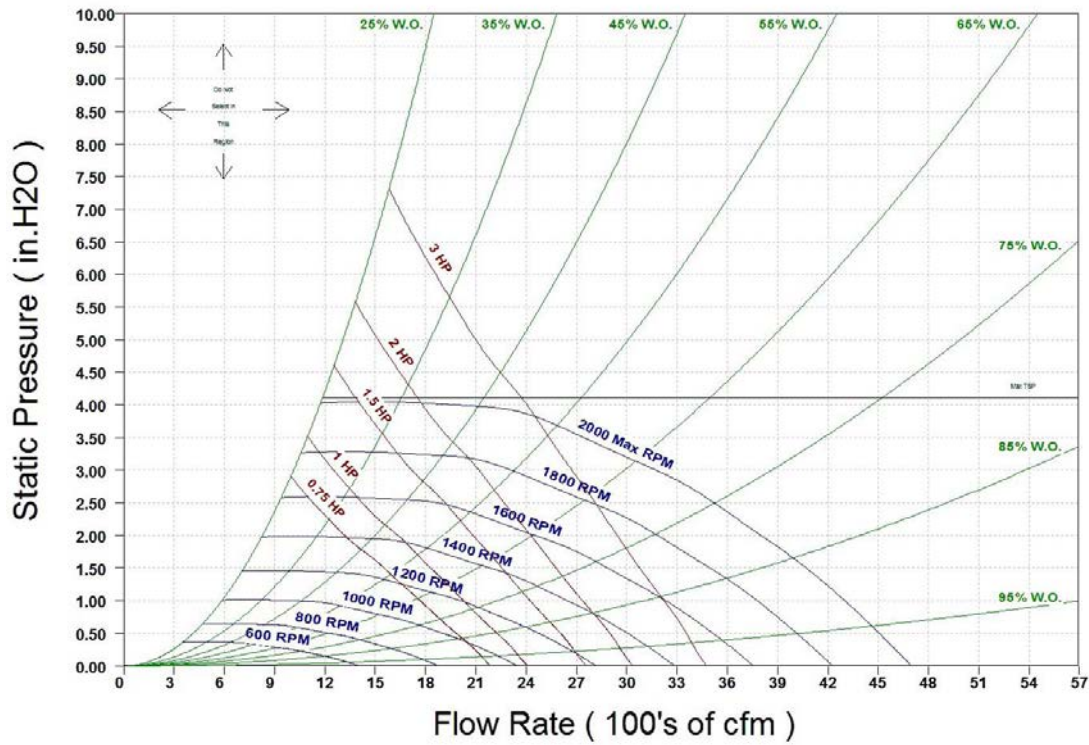

AMI06 (Fan 12-09 Class I)

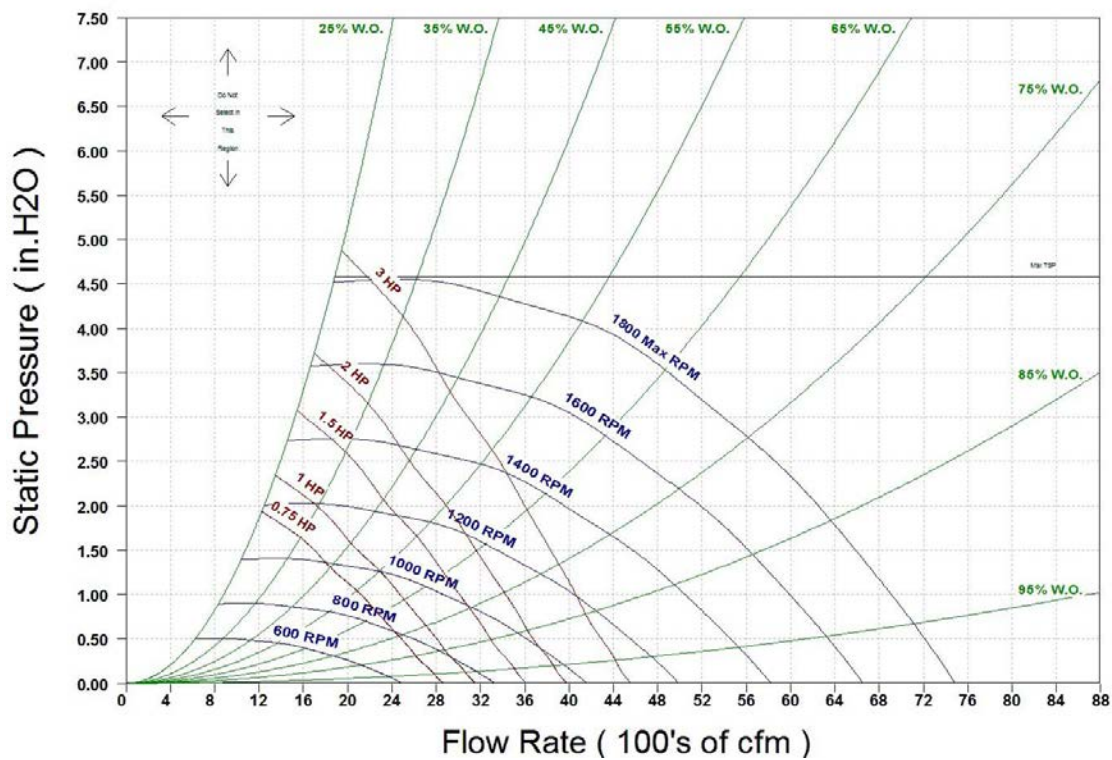

AMI08 (Fan 12-12 Class I)

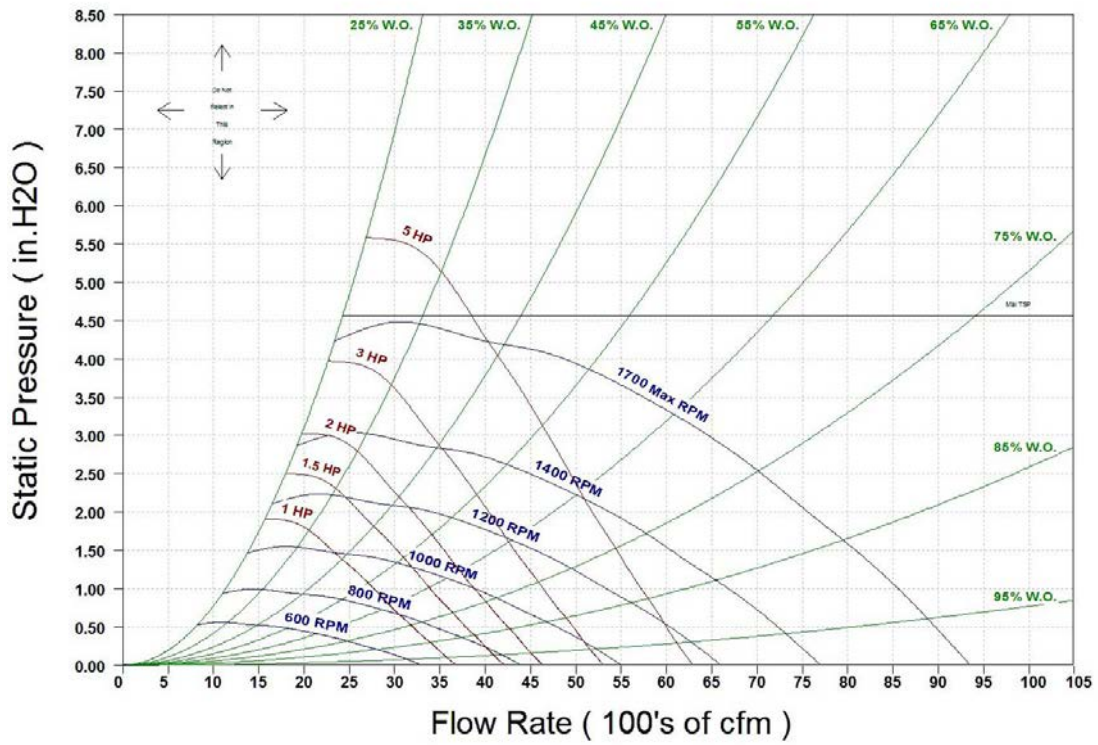

AMI10 (Fan 15-11 Class I)

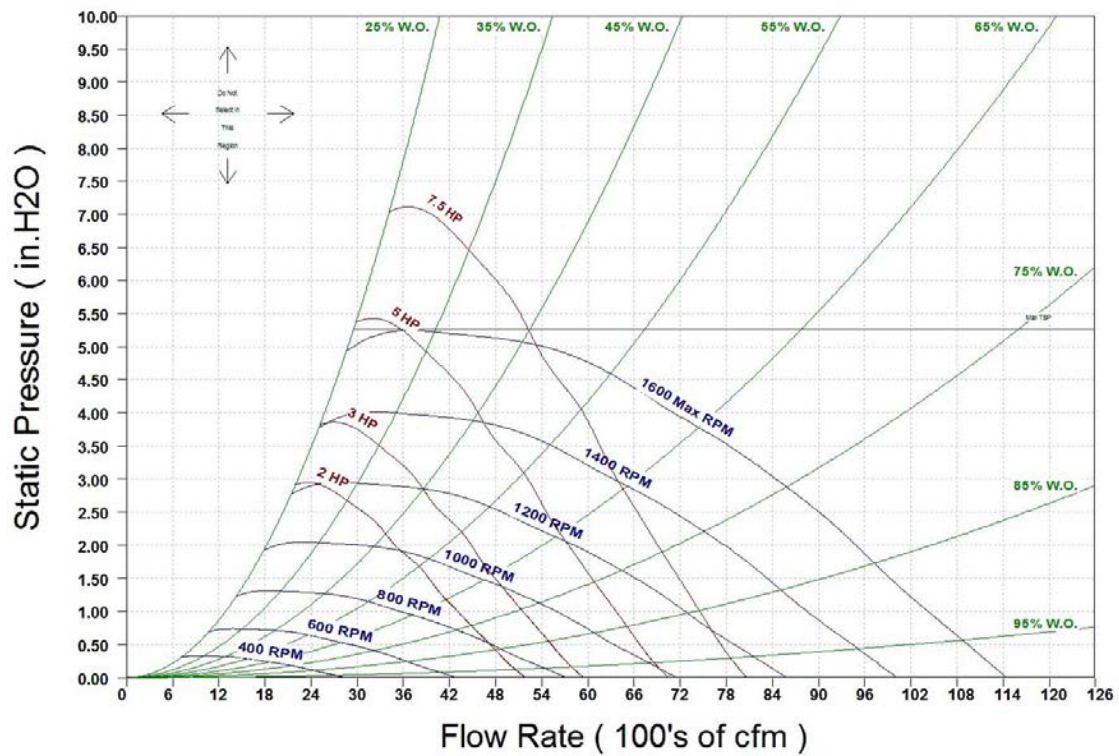

AMI12 (Fan 18-13 Class I)

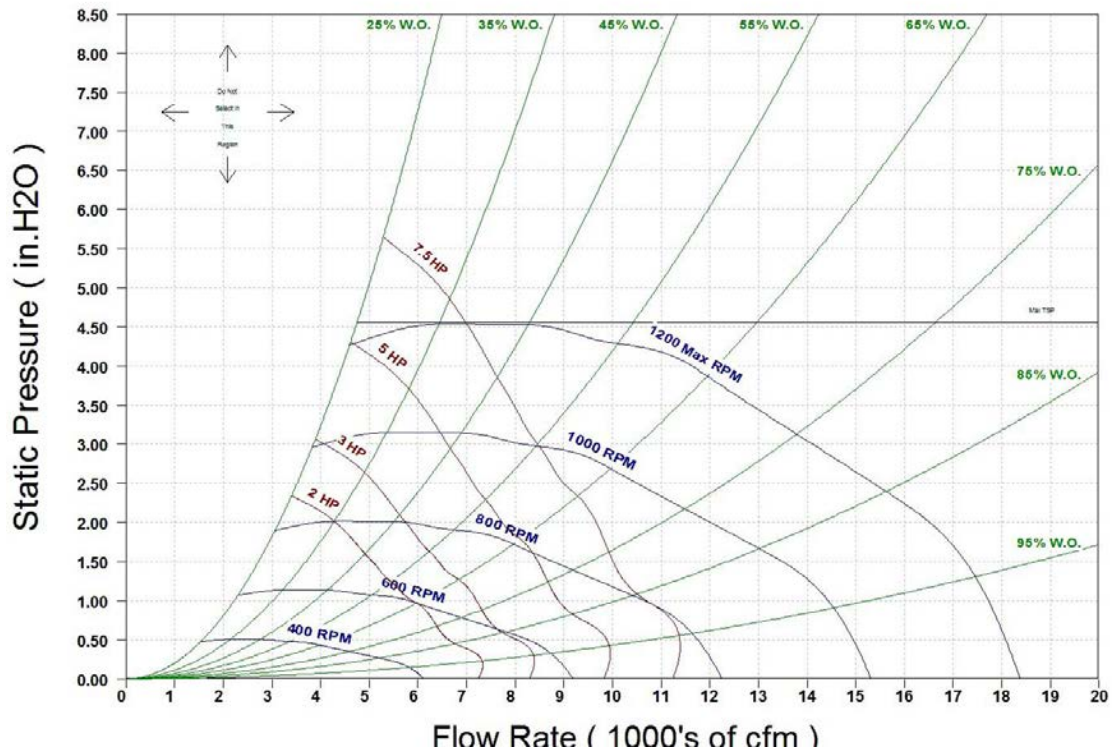

AMI12 (Fan 18-13 Class II)

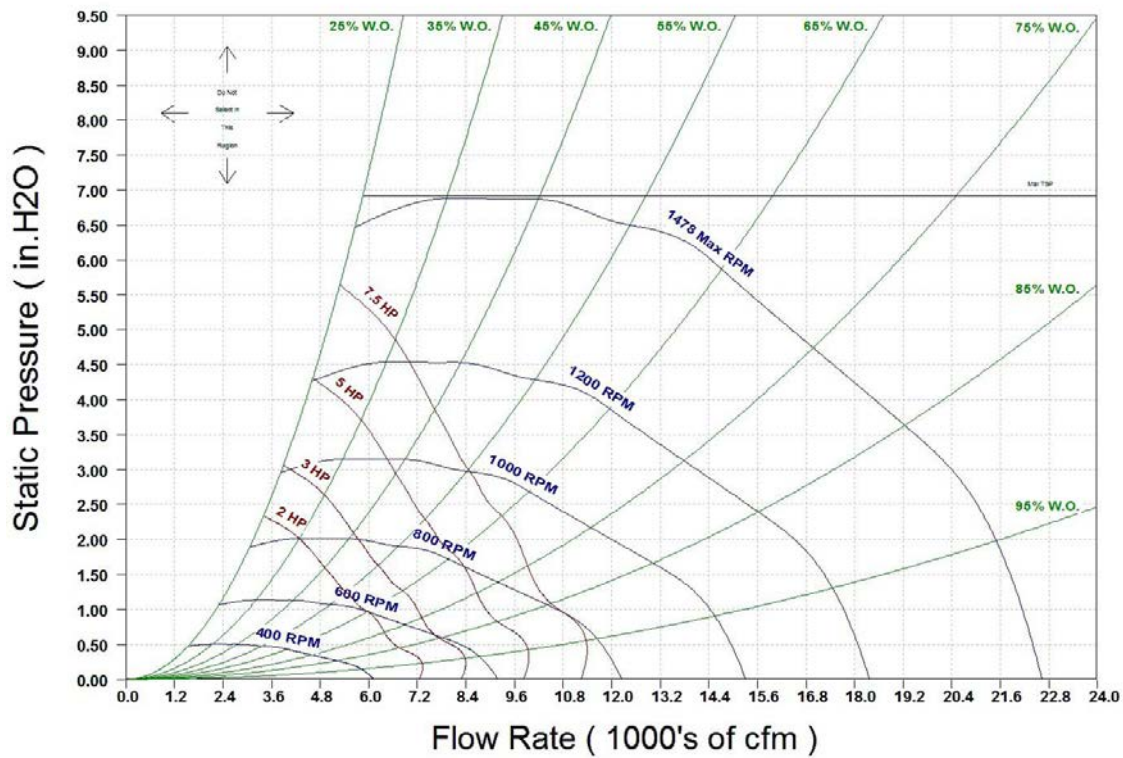

AMI14 (Fan 18-18 Class I)

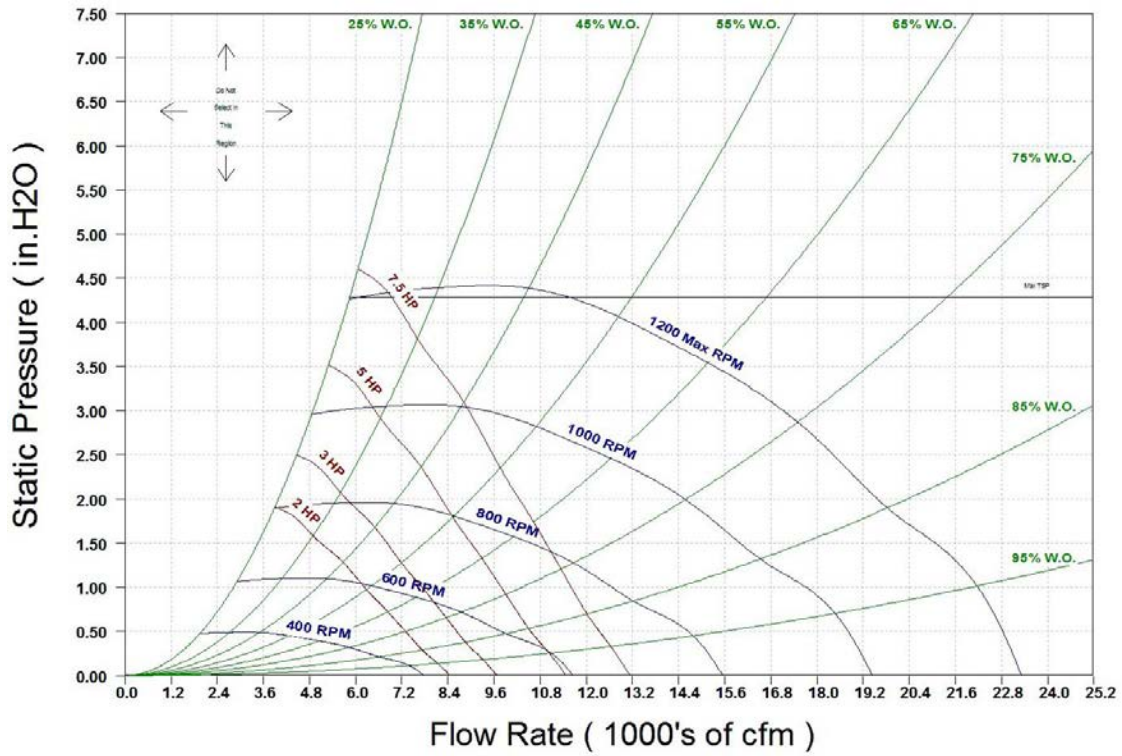

AMI14 (Fan 18-18 Class II)

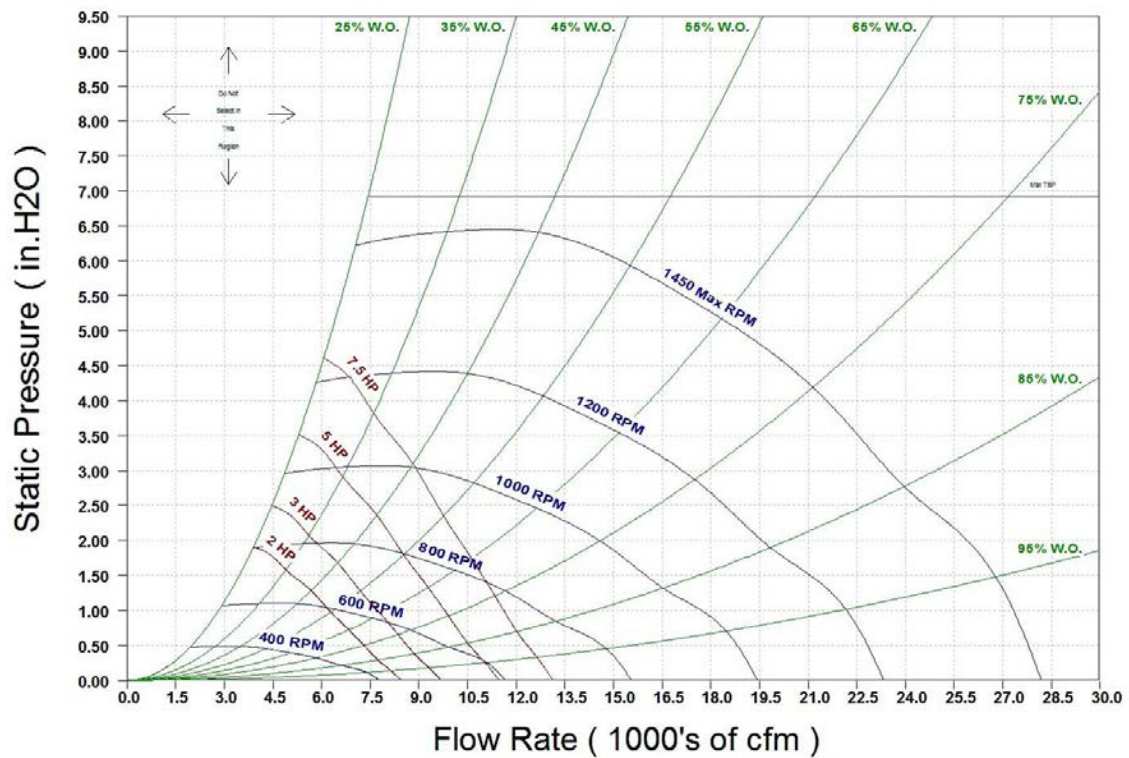

AMI17 (Fan 18-18 Class I)

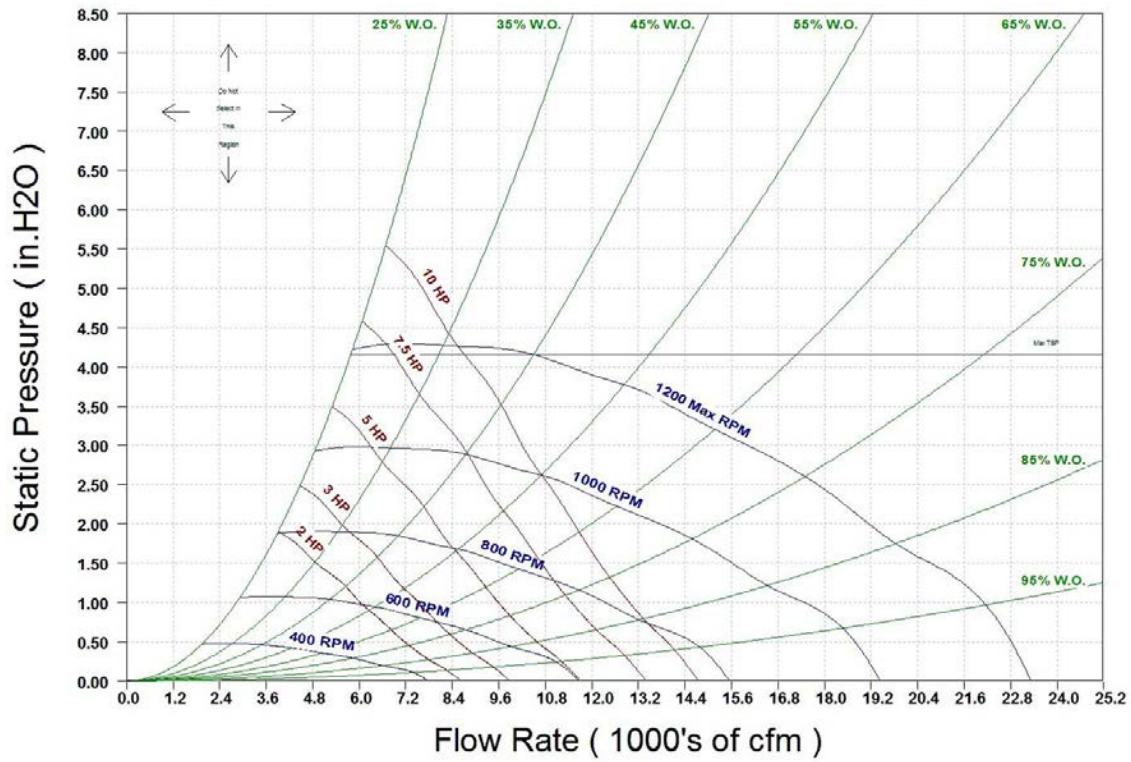

AMI17 (Fan 18-18 Class II)

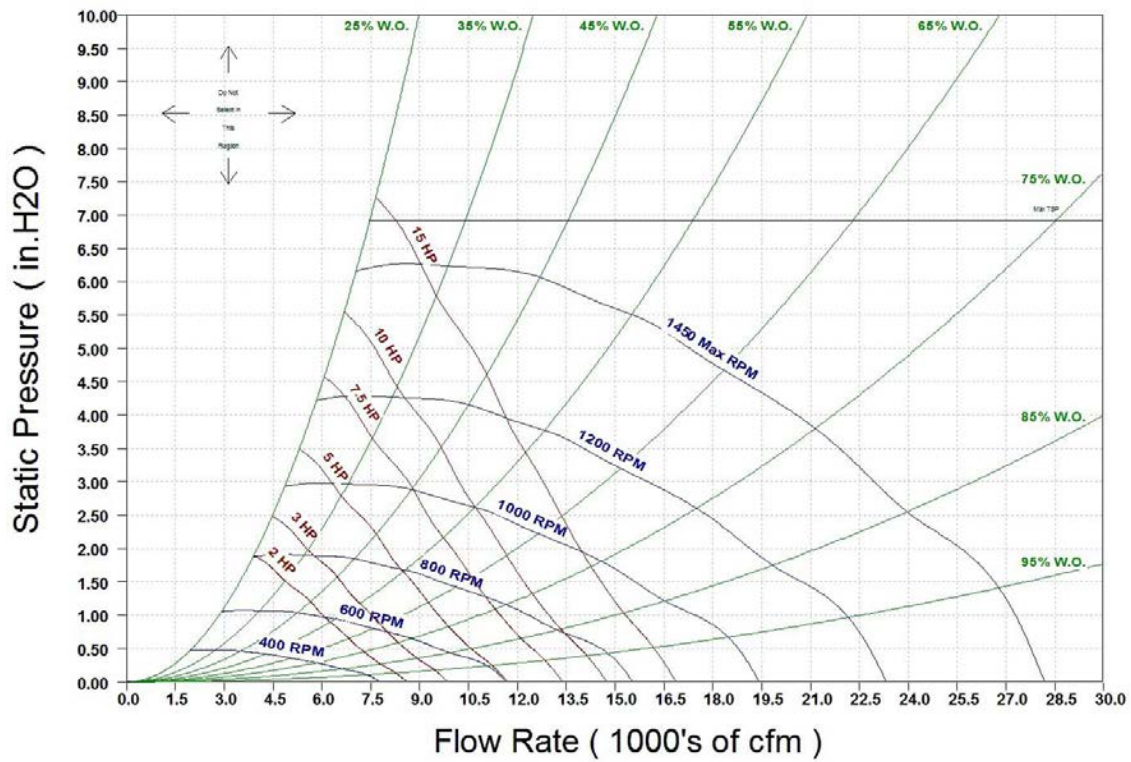

AMI02 (Fan 135-60 Class I)

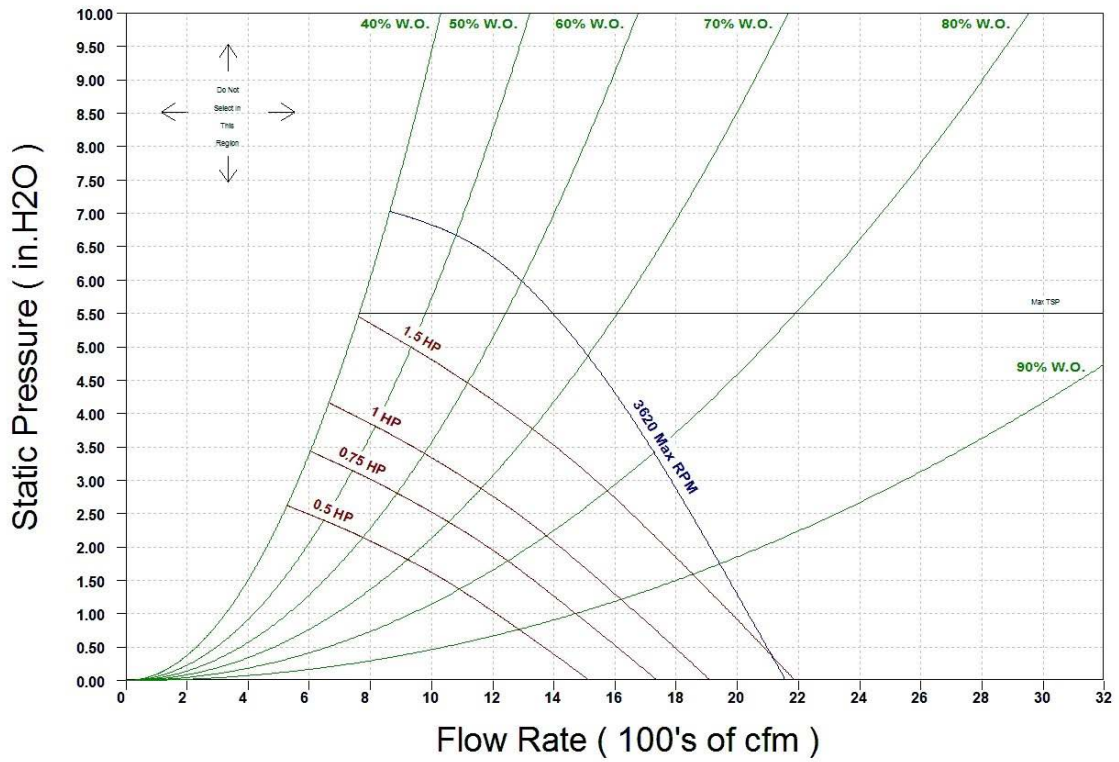

AMI03 (Fan 135-85 Class I)

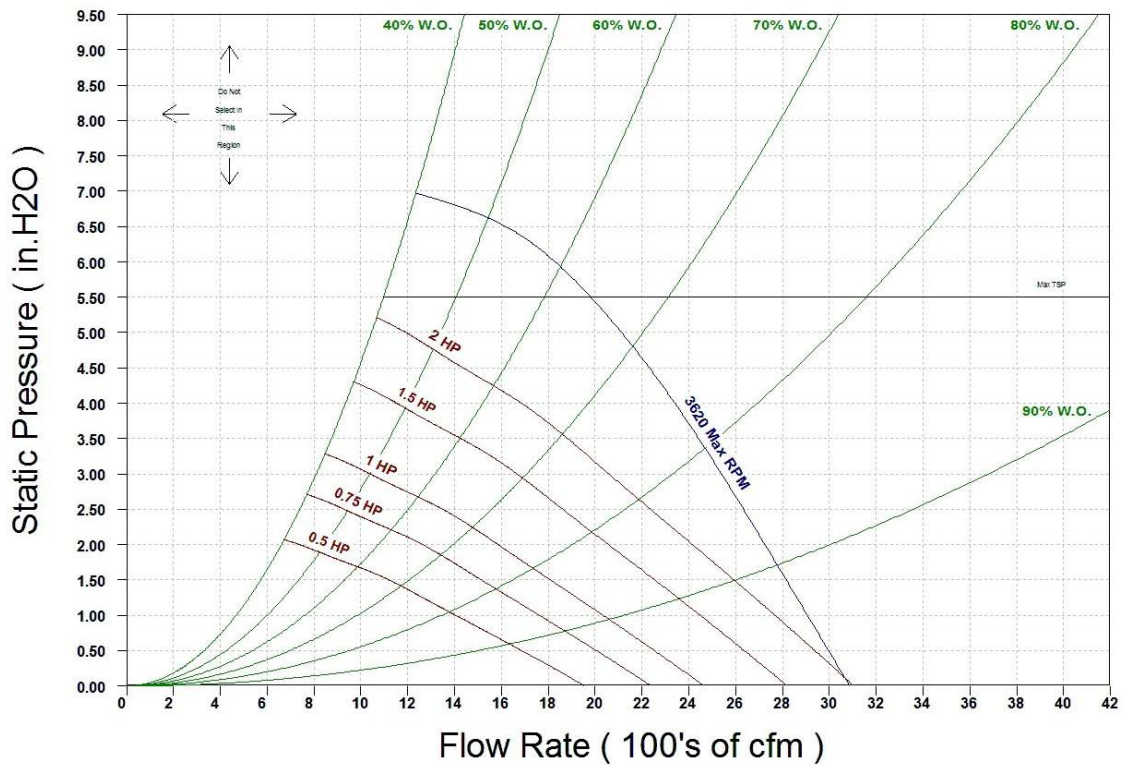

AMI04 (Fan 135-100 Class I)

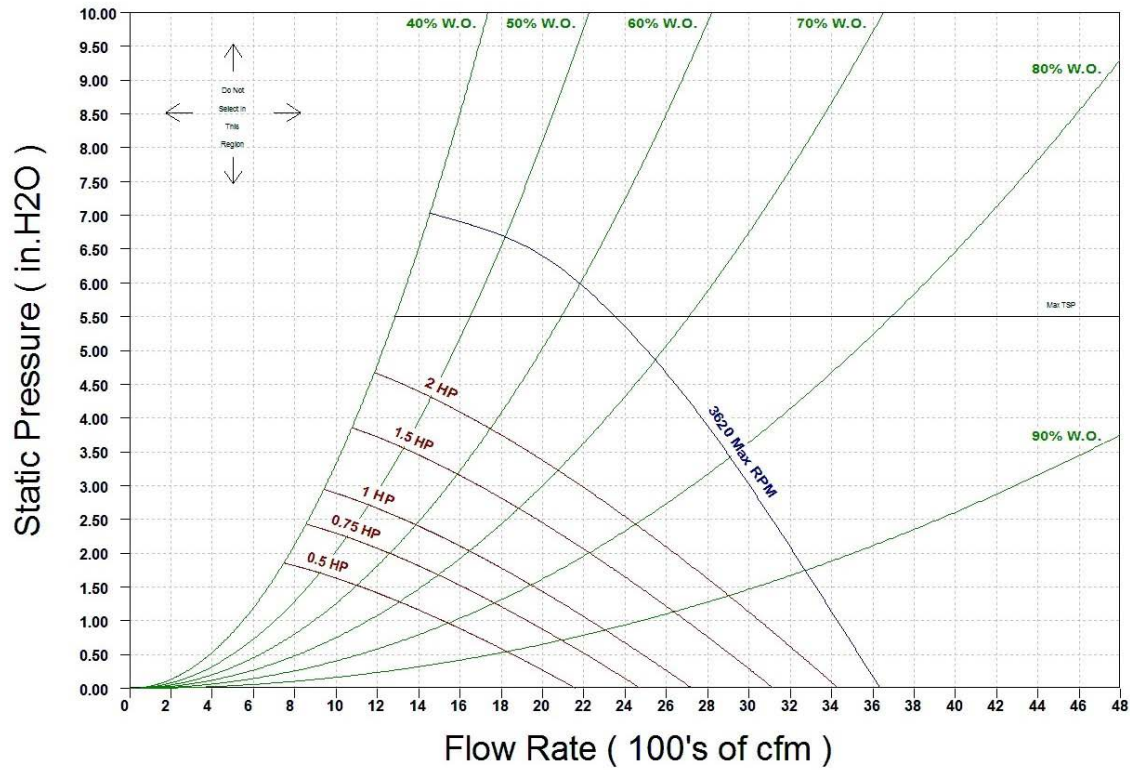

AMI06 (Fan 185-100 Class I)

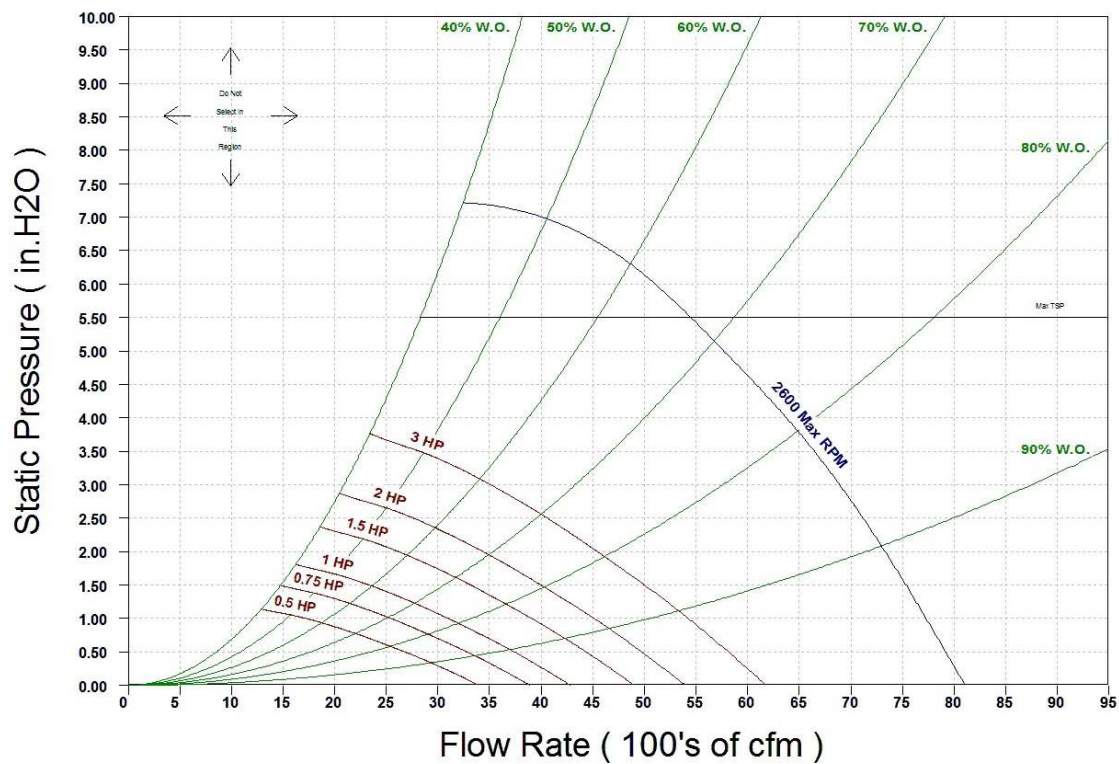

AMI08 (Fan 220-80 Class I)

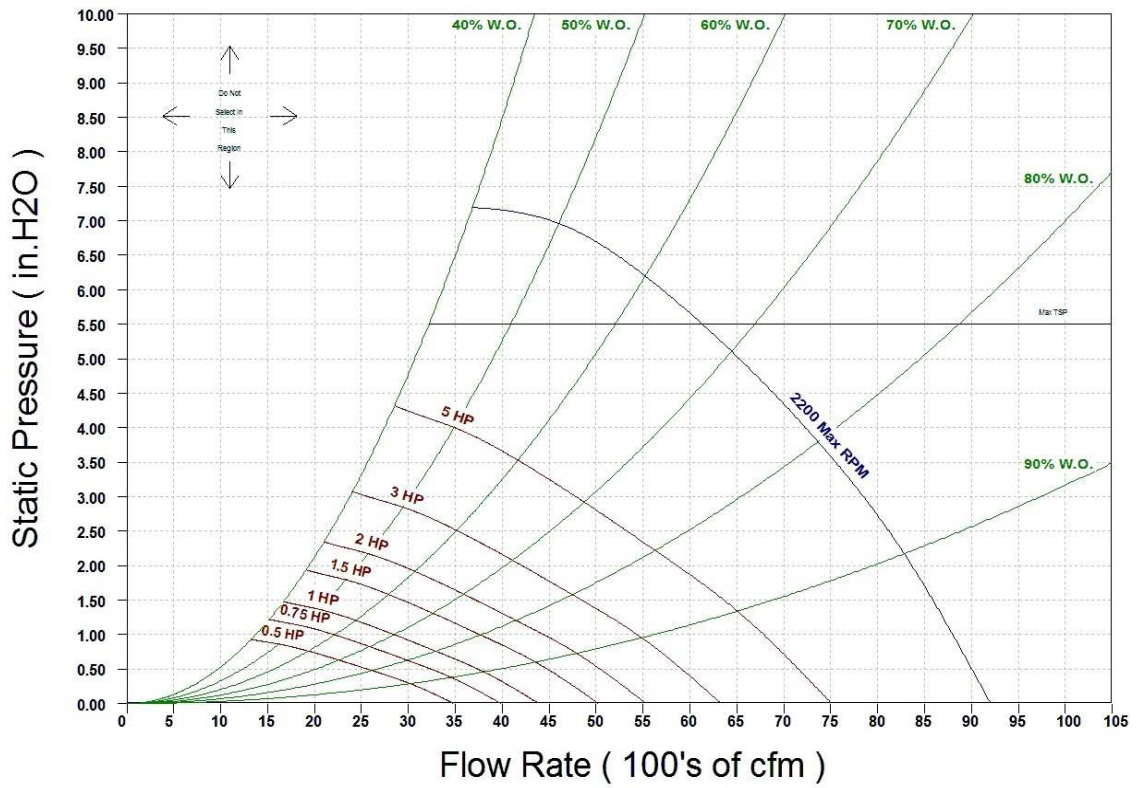

AMI10 (Fan 220-100 Class 1)

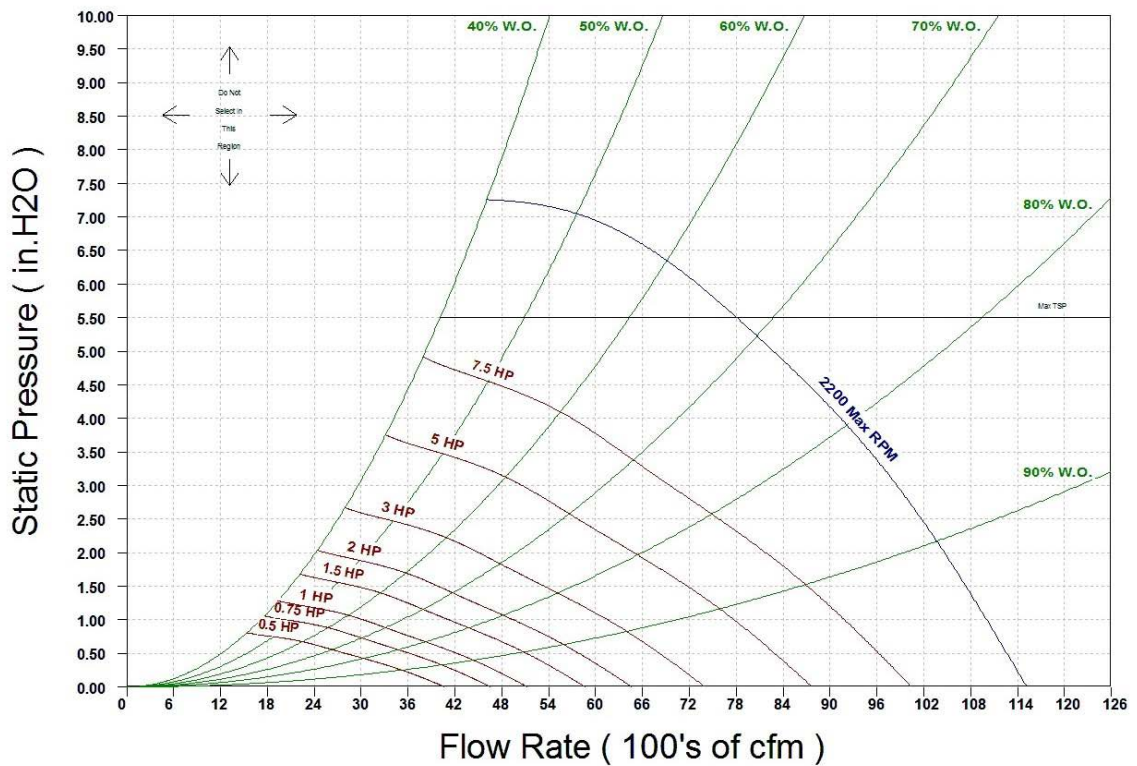

AMI12 (Fan 245-100 Class I)

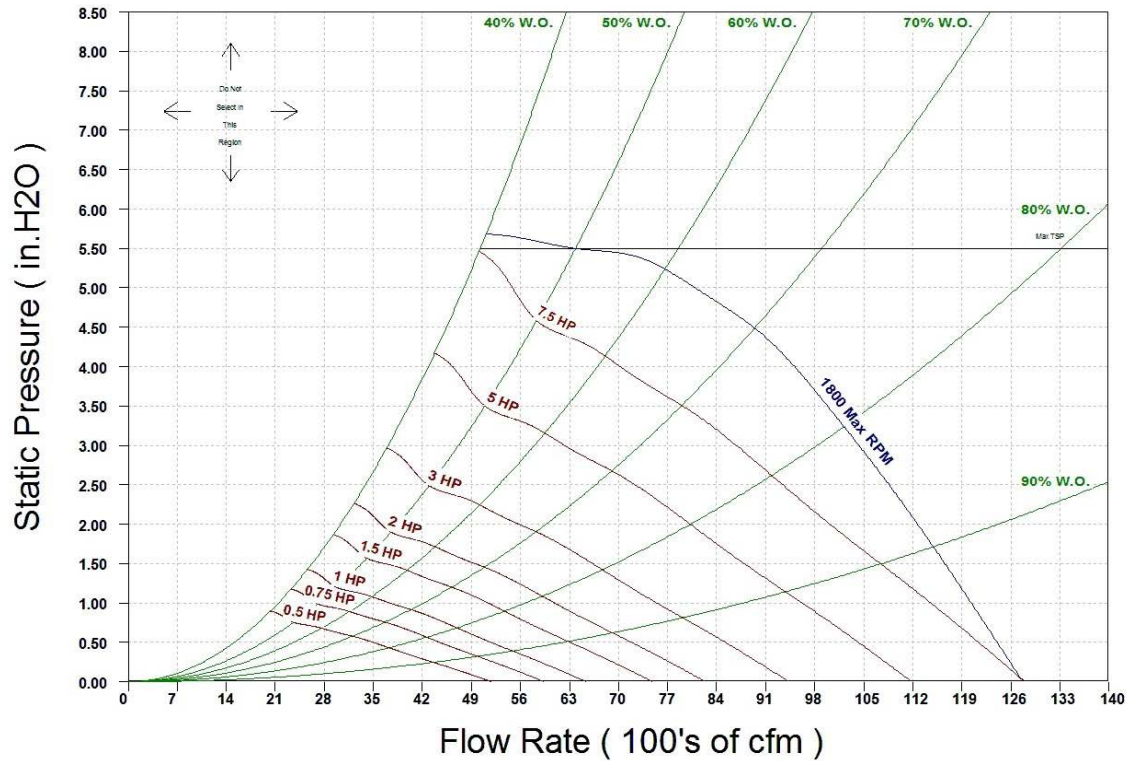

AMI17 (Fan 270-100 Class I)

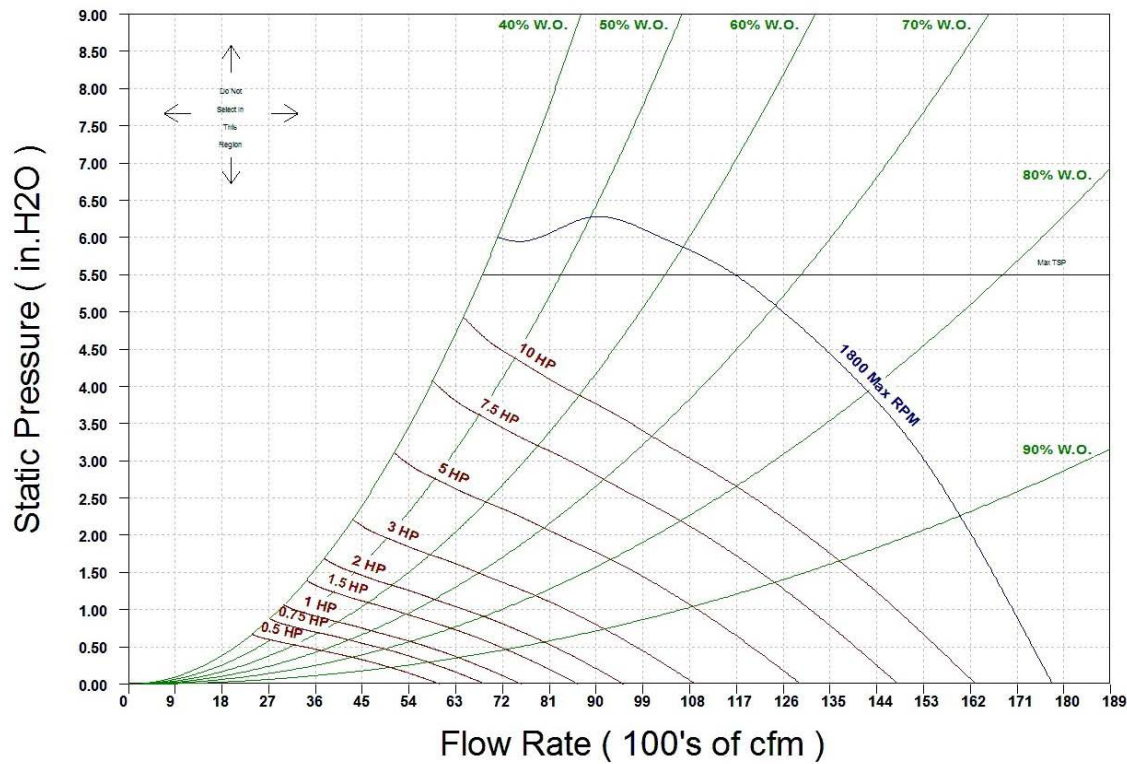

GUIDE SPECIFICATIONS

Air-Handling Unit

HVAC Guide Specifications - Section 15XXX Size Range: 600 – 10,000 CFM
Johnson Controls Model Number: AMI

Part 1 — General

1.01 SYSTEM DESCRIPTION

- A. Indoor mounted air-handling unit designed to provide air to a conditioned space as required to meet specified performance requirements for ventilation, heating, cooling, filtration and air distribution. Unit shall be assembled for draw thru application and shall be arranged to discharge conditioned air horizontally or vertically as shown on the contract drawings.
- B. Unit with a direct-expansion cooling coil shall have the capability to be used in a refrigerant circuit in conjunction with a field supplied and matched air-cooled condensing unit.

1.02 QUALITY ASSURANCE

- A. Coils shall be tested in accordance with AHRI 410 "Standard for Forced-Circulation Air-Cooling and Air-Heating Coils".
- B. Direct expansion coils shall be designed and tested in accordance with ANSI/ASHRAE 15 "Safety Code for Refrigeration Systems".
- C. Insulation and insulation adhesive shall comply with NFPA 90A and 90B requirements for flame spread and smoke generation.
- D. Unit shall be constructed in accordance with UL 1995 standards, comply with NEMA standards and shall carry the cETL label, display certification symbol on units of certified models. Installation of ancillary electrical components shall comply with NEC.

1.03 DELIVERY, STORAGE AND HANDLING

Unit shall be stored and handled in accordance with the unit manufacturer's instructions.

Part 2 — Products

2.01 EQUIPMENT

- A. General: Factory assembled air-handling unit that is modular in design and construction. Unit may consist of a fan and coil section with factory-installed chilled water or direct expansion coil, preheat or reheat coil, heating coil section, filter section, combination filter/mixing box (flat or V-bank arrangement), economizer, or access section(s) as indicated on the equipment schedules.
- B. Unit Cabinet:
 - 1. Unit panels shall be constructed of G60 galvanized steel and shall be capable of withstanding 125-hour salt spray test per ASTM Standard 117. All casing panels shall be removable for easy access to the unit. All panels shall be gasketed to ensure a tight seal.
 - 2. Double wall unit panels (includes corner posts, mullions and access doors) shall be 1-in. nominal thickness using 1.5-lbs/ft³ fiberglass insulation between galvanized steel panels.
 - 3. Single wall unit panels shall be 1-in. nominal thickness using matt-faced fiberglass insulation with a nominal density of not less than 1.5-lbs/ft³.
 - 4. Insulation shall be secured to casing with water based adhesive and weld pins where necessary, corresponding to 25/50-flame spread/smoke developed.
 - 5. Condensate drain pans shall be sloped to prevent standing water and shall be constructed of 18 gauge G60 galvanized steel or stainless steel; they shall have a galvanized steel or stainless steel male pipe threaded drain connection.

C. Fan Section:

1. Fan sections shall be constructed of G60 steel and shall have a formed channel base for integral mounting of fan, motor, and casing panels. Fan housing, wheel, shaft, and bearings shall be rigidly secured to the base unit.
2. Fan decks shall be internally spring isolated (one-inch deflection) with the fan outlet connection to be made using canvas duct.
3. Each unit shall have one fan wheel and housing only.
4. Fan wheels shall be designed for continuous operation at the maximum rated fan speed and motor horsepower. Fan wheels and shafts shall be selected to operate at least 25% below the first critical speed, and shall be statically and dynamically balanced as an assembly.
5. Fan shafts shall be solid steel, turned, ground and polished.
6. Fan bearings shall be a self-aligning, non-regreasable ball bearing type selected for an average life (L50) of 100,000 hours at design operation conditions, per ANSI Code B3.15.
7. Fan motor shall be mounted within the fan section casing. Motor shall be NEMA Design B with sizes and electrical characteristics as shown on the equipment schedule.
8. Fan drive shall be designed for a minimum of 1.15 service factor and shall be factory mounted and aligned. Belt drive package shall be variable-pitch type (constant volume) or fixed-pitch type (variable volume).

D. Coil Sections:

1. All coils shall have aluminum plate fins mechanically bonded to 1/2-in. OD seamless copper tubes by mechanical expansion. Coils shall be factory leak tested at 350-psig air pressure under water. Copper tubes shall be either 0.016" or 0.025" copper tube wall thickness. Coils shall have G60 galvanized steel or stainless steel casings with copper headers and sweat connections.
2. Chilled water coils shall have a working pressure of 300 psig at 200° F. No turbulence-promoting devices will be permitted inside the tubes. Headers shall have vent connections.
3. Direct-expansion coils shall be provided with pressure-type brass distributors with solder-type connections. Coils shall be designed and tested in accordance with ANSI/ASHRAE 15.
4. Hot water coils shall have a working pressure of 300 psig at 200° F. No turbulence-promoting devices will be permitted inside the tubes. Headers shall have vent connections.
5. Steam distributing coils (standard single tube type) shall have a maximum working pressure of 15 psig at ambient temperatures above 35° F. Tube wall thickness shall be 0.025" as standard.
6. Electric heat coils for use in blower coil units shall be open coil type, nichrome wire resistance elements, insulated by floating ceramic bushings. Thermal cutouts for primary and secondary over-temperature protection shall be provided to meet UL and NEC requirements. Maximum element watt density shall be 55-watts/sq inch. The manufacturer shall furnish an integral control box. It shall contain primary and secondary control thermal cutouts, relays, airflow switch, and fused control transformer.

E. Filter Sections:

1. Each filter section shall be designed and constructed to house the specific type of filter specified on the equipment schedule.
2. Flat filter sections shall accept 2-in. 30% (MERV-6) pleated filters of standard sizes. Sections shall include side access slide rails. Flat filter section shall be arranged with minimum depth in direction of airflow.
3. Angle filter section shall accept 2-in. 30% (MERV-6) pleated filters of standard sizes arranged in horizontal V formation. Sections shall include side access slide rails.

F. Damper Sections:

1. Mixing boxes, filter mixing boxes and economizers shall have parallel blade, interconnecting dampers. Damper blades shall have parallel bends for stiffness and shall be mechanically fastened to steel rods rotating in brass bushings and mounted in rigid galvanized steel frames. Dampers shall be sectionalized to limit blade width, minimize blade warpage, and ensure tight closure.
2. All dampers for mixing boxes and filter mixing boxes shall be rated with a leakage rate not to exceed 5% of air quantity calculated at 2000 fpm velocity through damper and 4.0-in.wg. pressure difference. Damper blades shall be gasketed and stainless steel perimeter-sealing strips shall be provided. Damper linkage shall be provided and installed with all mixing boxes.

G. Access Sections:

1. Access sections shall be installed where indicated on the drawings and shall be as specified on the equipment schedule.
2. Access sections shall have removable access panels.

H. Special Features

The following unit options shall be available.

1. Fan Section:

- a. Variable frequency drives.
- b. Motor starters – contactor with overload for three phase and contactor for single phase.
- c. High-efficiency motors (inverter-duty).
- d. Totally enclosed fan cooled (TEFC) motors (inverter-duty).
- e. Two-speed motors.
- f. Direct drive plenum fans with internal isolation.
- g. Class II forward curved fans with regreasable pillow block bearings.
- h. Exhaust or return fans for use with economizer sections.

2. Coil Section:

- a. Chilled water coil with copper plate fins and/or stainless steel casing.
- b. Direct-expansion coil with copper plate fins and/or stainless steel casing.
- c. Hot water coil with copper plate fins and/or stainless steel casing.
- d. Steam distributing coil with copper plate fins and/or stainless steel casing.

3. Filtration:

- a. 4" pleated filter type (standard size), 60-65% efficiency (MERV-11)
- b. 4" pleated filter type (standard size), 80-85% efficiency (MERV-13)
- c. 4" pleated filter type (standard size), 90-95% efficiency (MERV-14)

4. Access Doors: Hinged (lift-off type) doors with quick-action latches (handles) on both sides of the section for access to both the fan and filter from either side of the unit.

5. Base Rail: Unit mounted base rail shall be a minimum of 4" in height and constructed of galvanized steel, structurally capable of supporting unit on floor or by ceiling suspension.

I. End Devices:

The following guide specifications should be used as a basis for design when using optional factory/field-mounted direct digital controls. These specifications should be reviewed to match the specific system control requirements and available control packages.

-
1. The electrical components shall be recognized by UL. The unit shall be in compliance with the UL 1995 standards. Fan motors are wired and terminated in the control enclosure.
 2. All application software performing the required control functions shall be field-supplied with the DDC controller factory or field mounted and wired (tested and configured).
 3. Available End Devices and Controls:
 - a. Variable Frequency Drives
 - Factory supplied and mounted
 - Field supplied and factory mounted
 - b. Motor Starters
 - Factory supplied and mounted
 - Field supplied and factory mounted
 - c. End Devices (factory supplied and mounted)
 - Disconnect switch (fused or non-fused)
 - Damper actuator (modulating from 100% OA to 100% RA)
 - Fuses, relays, transformers, etc.
 - Electric heat interlock relay
 - Hand off auto switch

METRIC CONVERSION CHART

SI UNIT	CONVERSION FACTOR	= ENGLISH UNIT	CONVERSION FACTOR	= SI UNIT	SI UNIT	CONVERSION FACTOR	= ENGLISH UNIT	CONVERSION FACTOR	= SI UNIT
Area					Temperature Interval				
cm ²			100	mm ²	°C	1.8	°F	0.5556	°C
cm ²	0.1550	in ²	645.2	mm ²	Velocity				
m ²	10.76	ft ²	0.09290	m ²	m/s	3.281	ft/s	0.3048	m/s
Length					m/s	196.9	ft/min	0.00508	m/s
mm	0.03937	in.	25.4	mm	Volume				
mm	0.003281	ft.	304.8	mm	mm ³			1.0x10-6	L
m	3.281	ft.	0.3048	m	mm ³	6.102x10-5	in. ³	0.01639	L
m	1.094	yd.	0.9144	m	L	0.03531	ft ³	28.32	L
Mass					m ³	1.308	yd ³	0.7646	m ³
g	0.03527	oz.	28.35	g	L	0.2642	U.S. gal	3.785	L
kg	2.205	lb.	0.4536	kg	L	2.113	U.S. pint	0.4732	L
tonne, Mg	1.102	U.S. ton (2000 lb.)	0.9072	tonne, Mg	mL, cm ³	0.03381	U.S. oz	29.57	mL
Power					Volume / Time				
kcal/h			1.163	W	m ³ /h			0.2778	L/s
kcal/h	3.968	Btu/h	0.2931	W	m ³ /h	0.5886	ft ³ /min	0.4719	L/s
HP metric			0.7355	kW	m ³ /h	4.403	U.S. gal/min	0.06309	L/s
HP metric	0.9863	HP (550)	0.7457	kW	L/h			2.778x10 ⁻⁴	L/s
Mcal/h			1.163	kW	L/h	4.403x10-3	U.S. gal/min	0.06309	L/s
Mcal/h	0.3307	Ton refr.	3.517	kW	(m ³ /h)/ (1000 kcal/h)	1.780	cfm/ton	0.1342	L/s - kW
Pressure									
mm w.g. 4°C			9.806	Pa					
mm w.g. 4°C	0.03937	in H ₂ O 39.2°F	249.1	Pa					
mm Hg 0°C			0.1333	kPa	SI UNIT	CONVERSION FACTOR	= ENGLISH UNIT	CONVERSION FACTOR	= SI UNIT
mm Hg 0°C	0.03937	in Hg 32°F	3.386	kPa					
kgf/cm ²			98.07	kPa	Temperature				
kgf/cm ²	14.22	psi	6.895	kPa	°C			°C + 273.15	°K
mH ₂ O	3.281	ft H ₂ O	2.989	kPa	°C	(°C x 1.8) + 32	°F	(°F - 32) ÷ 1.8	°C

PREFIXES

M	MEGA-	10 ⁶
k	KILO-	10 ³
d	DECI	10 ⁻¹
c	CENTI	10 ⁻²
m	MILLI	10 ⁻³

LEGEND

m	METER
cal	CALORIE
kg	KILOGRAM (mass)
kgf	KILOGRAM - FORCE
kp	KILOGRAM - FORCE
L	LITER
°C	DEGREES CELSIUS
K	KELVIN
W	WATT
Pa	PASCAL
J	JOULE
N	NEWTON
h	HOUR
m	MINUTE
s	SECOND

UNITS

HP metric =	METRIC HORSEPOWER
mm w.g. =	MILLIMETERS WATER GAUGE
mmCE =	MILLIMETERS WATER GAUGE
mmHg =	MILLIMETERS MERCURY
tonne =	1000 kg
kcal =	kilocalories
bar =	100 KPa

STANDARD & OPTIONAL FEATURES

STANDARD FEATURES

Construction

- Modular design facilitates retrofit
- Galvanized steel cabinet construction
- 1" thick fiberglass insulation, glued and pinned in place
- Gasketed, removable access panels sized for easy handling
- Left and right hand arrangement
- Access panels on all sections

Fan Assembly

- Single forward-curved fan sections
- Statically and dynamically balanced
- Solid steel shafting
- Ball bearings with a minimum design average life (L50) of 100,000 hours
- Fan decks with internal vibration isolation

Fan Motor and Drive

- Single speed ODP motors
- 1750 RPM single speed, 60 Hertz
- Single phase motors with inherent thermal protection
- Three phase motors
- Standard cross section "V-belt" drive with 1.2 service factor
- Adjustable pitch motor pulley and fixed pitch blower pulley

Coils

- 1/2" O.D. seamless copper tubes
- G60 steel coil casings
- Collared aluminum fins
- Manual air vent plug on all water coils
- 300 PSIG Working Pressure at 200°F
- Copper ODM sweat connections
- 0.016" tube wall on water and evaporator coils
- 0.025" tube wall on steam coils

Filters and Filter Rack

- Hinged side access flat filter rack
- 2" pleated filters (30%)

Electrical

- Fan motor wired and terminated to junction box
- All units cETL listed in compliance with UL/ANSI 1995

Electric Heat Section

- Draw Thru or Blow Thru configurations
- Factory mounted electric heater with single point power connection, ETL listed as an assembly

OPTIONAL FEATURES

Construction

- Double wall (solid or perforated) cabinets
- Stainless steel IAQ drain pan with stainless steel male pipe threaded connection
- Fan discharge arrangements
- Scrim reinforced foil faced insulation
- Hinged access panels with lift and turn fasteners
- 4" Base rails with rigging slots factory assembled and installed

Fan Motor and Drive

- Direct drive plenum fans with internal rubber-in-shear (RIS) isolation
- TEFC motors
- High efficiency motors
- Two-speed motors with contactors
- Variable frequency drives, factory installed (mounted and wired)
- Motor starter (contactor with overload for three phase; contactor for single phase), factory installed (mounted and wired)
- Return FC and plenum fan sections

Coils

- 3, 4, 6 and 8 row chilled water or DX coils
- Up to 4 rows hot water or up to 2 rows standard steam
- Heating coil in preheat or reheat position
- Coil connections opposite handing

- Stainless steel coil casings
- 0.025" tube wall thickness
- Auto air vents

Filters and Filter Rack

- 4" high efficiency pleated filters (65, 85, and 95%)
- Mixing box with filter sections (flat or v-bank filter arrangements)

Inlet Damper Section

- Factory assembled and installed
- Heavy gauge galvanized steel formed blade dampers
- Low leak dampers with extruded vinyl blade seals and flexible metal jamb seals
- Medium and large inlet plenums with v-bank or flat filters
- Parallel blade operation
- Interconnecting damper linkage
- Damper actuator (modulating from 100% OA to 100% RA)

Additional Modules

- Face and bypass with medium and small coils
- Economizer sections
- Discharge plenums
- Access sections

Electrical

- Motor wiring in conduit
- Single phase fan control package
- Three phase fan control package
- Door interlocking disconnect switch (non-fused or fused)
- Fusing (main or per stage)
- Hand off auto switch (HOA)
- Frequency inverters
- Electric heat interlock relay
- Relays, transformers, etc.